



| an EnerSys® company

# Alpha Modular Switched Mode Rectifier System

Models:

**Cordex® CXRF 48-3.6kW**

**Cordex® HP CXRF 48-4kW, 48-4.6kW, 48-12kW**

Technical Guide: 9400000-J0

Effective: 06/2020



# Modular Switched Mode Rectifier System

Models: Cordex<sup>®</sup> CXRF HP 48-12kW

Cordex<sup>®</sup> CXRF HP 48-4.0kW

Cordex<sup>®</sup> CXRF HP 48-4.6kW

Cordex<sup>®</sup> CXRF 48-3.6kW



---

**NOTE:**

Photographs contained in this manual are for illustrative purposes only. These photographs may not match your installation.



---

**NOTE:**

Operator is cautioned to review the drawings and illustrations contained in this manual before proceeding. If there are questions regarding the safe operation of this powering system, contact Alpha Technologies or your nearest Alpha representative.



---

**NOTE:**

Alpha<sup>®</sup> shall not be held liable for any damage or injury involving its enclosures, power supplies, generators, batteries, or other hardware if used or operated in any manner or subject to any condition inconsistent with its intended purpose, or if installed or operated in an unapproved manner, or improperly maintained.

For technical support, contact Alpha Technologies:

Canada and USA: **1-888-462-7487**

International: **+1-604-436-5547**

Email: **support@alpha.ca**

## Copyright

Copyright © 2020 Alpha Technologies Ltd. All rights reserved. Alpha is a registered trademark of Alpha Technologies.

No part of this documentation shall be reproduced, stored in a retrieval system, translated, transcribed, or transmitted in any form or by any means manual, electric, electronic, electromechanical, chemical, optical, or otherwise without prior explicit written permission from Alpha Technologies.

This document, the software it describes, and the information and know-how they contain constitute the proprietary, confidential and valuable trade secret information of Alpha Technologies, and may not be used for any unauthorized purpose, or disclosed to others without the prior written permission of Alpha Technologies.

The material contained in this document is for information only and is subject to change without notice. While reasonable efforts have been made in the preparation of this document to assure its accuracy, Alpha Technologies assumes no liability resulting from errors or omissions in this document, or from the use of the information contained herein. Alpha Technologies reserves the right to make changes in the product design without reservation and without notification to its users.

# Table of Contents

1. Safety.....	5
1.1 Safety Symbols .....	5
1.2 General Safety .....	5
1.3 Mechanical Safety.....	5
1.4 Electrical Safety .....	6
1.5 Battery Safety .....	6
2. Introduction .....	7
2.1 Scope of the Manual .....	7
2.2 Product Overview.....	7
3. Specifications.....	8
4. Features.....	11
4.1 Rectifier.....	11
4.2 Cordex® HP Controller (CXC HP) .....	15
5. Inspection.....	17
5.1 Packing Materials.....	17
5.2 Check for Damage .....	17
5.3 General Receipt of Shipment.....	17
6. Installation.....	18
6.1 Safety Precautions.....	18
6.2 Tools Required .....	18
6.3 Power System Assembly and Mounting.....	19
7. Wiring.....	20
7.1 Grounding .....	20
7.2 AC Feeder Protection/Sizing.....	20
7.3 AC Wiring .....	21
7.4 DC Wiring.....	21
7.5 CAN Serial Ports.....	22
7.6 Shelf ID Connection .....	23
7.7 Signal Wiring Connections to L-ADIO Board .....	24

8. System Startup .....	26
8.1 Check System Connections .....	26
8.2 Verify AC and Power the Rectifier Shelf.....	26
8.3 Triple Check Battery Polarity and Connections.....	26
8.4 CXC HP Reset .....	26
9. Operation .....	27
9.1 Main Rectifier States .....	27
9.2 Main Rectifier Modes .....	27
9.3 Factory Ranges and Defaults .....	29
10. Maintenance .....	30
10.1 Replacing a Rectifier Module .....	30
10.2 Fan and Fan Filter Replacement .....	31
10.3 MOV Replacement.....	35
11. Acronyms and Definitions.....	39
12. Warranty and Service Information .....	40
12.1 Technical Support .....	40
12.2 Warranty Statement .....	40
12.3 Product Warranty .....	40
12.4 Battery Warranty .....	40
12.5 Warranty Claims.....	40
12.6 Service Information .....	40
13. Certification .....	41

# List of Figures

- Figure 1 — Cordex 48-3.6kW ..... 7
- Figure 2 — Cordex 48-4kW/4.6kW ..... 7
- Figure 3 — Cordex 48-12kW ..... 7
- Figure 4 — Rectifier Front Panel LEDs..... 11
- Figure 5 — Cordex® HP Controller (left and right side views)..... 15
- Figure 6 — LCD Color Touchscreen Display ..... 16
- Figure 7 — CAN Port Connections ..... 22
- Figure 8 — Relay Connections in the De-energized State ..... 24
- Figure 9 — Digital Input Connection Method ..... 24
- Figure 10 — 4kW/4.6kW Rectifier Fan Removal ..... 32
- Figure 11 — Fan Assembly - Screw Removal..... 33
- Figure 12 — Fan Assembly Removal ..... 33

# 1. Safety

---

**SAVE THESE INSTRUCTIONS:** This manual contains important safety instructions that must be followed during the installation, servicing, and maintenance of the product. Keep it in a safe place. Review the drawings and illustrations contained in this manual before proceeding. If there are any questions regarding the safe installation or operation of this product, contact Alpha Technologies or the nearest Alpha representative. Save this document for future reference.

## 1.1 Safety Symbols

To reduce the risk of injury or death, and to ensure the continued safe operation of this product, the following symbols have been placed throughout this manual. Where these symbols appear, use extra care and attention.

The use of **ATTENTION** indicates specific regulatory/code requirements that may affect the placement of equipment and /or installation procedures.



### **NOTE:**

**A NOTE provides additional information to help complete a specific task or procedure. Notes are designated with a checkmark, the word NOTE, and a rule beneath which the information appears**



### **CAUTION!**

**CAUTION indicates safety information intended to PREVENT DAMAGE to material or equipment. Cautions are designated with a yellow warning triangle, the word CAUTION, and a rule beneath which the information appears.**



### **WARNING!**

**WARNING presents safety information to PREVENT INJURY OR DEATH to personnel. Warnings are indicated by a shock hazard icon, the word WARNING, and a rule beneath which the information appears.**



### **HOT!**

**The use of HOT presents safety information to PREVENT BURNS to the technician or user.**

## 1.2 General Safety



### **WARNING!**

**This system is designed to be installed in a restricted access location that is inaccessible to the general public.**

## 1.3 Mechanical Safety

- Keep hands and tools clear of fans. Fans are thermostatically controlled and switch on automatically.
- Power supplies can reach extreme temperatures under load.
- Use caution around sheet metal components and sharp edges.

## 1.4 Electrical Safety



### WARNING!

**Hazardous voltages are present at the input of power systems. The DC output from rectifiers and batteries, though not dangerous in voltage, has a high short-circuit current capacity that may cause severe burns and electrical arcing.**

- Before working with any live battery or power system, follow these precautions:
  - a. Remove all metallic jewelry, such as watches, rings, metal rimmed glasses, or necklaces.
  - b. Wear safety glasses with side shields at all times during the installation.
  - c. Use OSHA approved insulated hand tools.



### WARNING!

**Lethal voltages are present within the power system. Always assume that an electrical connection or conductor is energized. Check the circuit with a voltmeter with respect to the grounded portion of the enclosure (both AC and DC) before performing any installation or removal procedure.**

- Do not work alone under hazardous conditions.
- A licensed electrician is required to install permanently wired equipment. Input voltages can range up to 240 Vac. Ensure that the utility power is disconnected and locked out before performing any installation or removal procedure.
- Ensure that no liquids or wet clothes come into contact with internal components.
- Hazardous electrically live parts inside this unit are energized from the batteries even when the AC input power is disconnected.

## 1.5 Battery Safety

- Servicing and connection of batteries must be performed by, or under the direct supervision of, personnel knowledgeable of batteries and the required safety precautions.
- Always wear eye protection, rubber gloves, and a protective vest when working near batteries. Remove all metallic objects from your hands and neck.
- Use OSHA approved insulated hand tools. Do not rest tools on top of batteries.
- Batteries contain or emit chemicals known to cause cancer and birth defects or other reproductive harm. Battery post terminals and related accessories contain lead and lead compounds. Wash your hands after handling batteries.



### WARNING!

**Follow battery manufacturer's safety recommendations when working around battery systems. Do not smoke or introduce an open flame when batteries (especially vented batteries) are charging. When charging, batteries vent hydrogen gas, which can explode.**

- Batteries are hazardous to the environment and should be disposed at a recycling facility. Consult the battery manufacturer for recommended local authorized recyclers.



## 2. Introduction

---

### 2.1 Scope of the Manual

This instruction manual explains the installation, interconnection, and operation of the Cordex® 48-3.6kW, 48-4.0kW, 48-4.6kW, and 48-12kW modular switched mode rectifier systems.

### 2.2 Product Overview

A complete Cordex rectifier system consists of one or more power modules in a common shelf enclosure. The shelf has connections for AC inputs, DC output, and system communications.

Rectifier modules use a high frequency, switched mode conversion technique to provide a fully regulated and isolated DC output from the AC mains. The rectifier input is wide range to allow use on 208/220/240/277 Vac 50/60 Hz electrical service.

Rectifier power modules are “hot swappable”—they can be inserted or removed from the shelf without cutting power to or from the system or the load.

Additional power modules can be included with the system at the time of ordering or added after the shelf has been installed.

The shelf rectifier system is designed to operate with the Cordex® System Controller. The controller allows the user to configure, monitor and control the entire DC power system from its touch screen display including temperature compensation, auto equalization, remote access, dial out on alarm, battery diagnostics, as well as Web server and SNMP support for configuration and monitoring. Details of controller operation are provided in the current version software manual, document #0350058-J0.

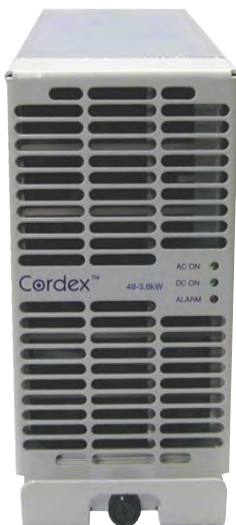

Figure 1 —  
Cordex 48-3.6kW



Figure 2 —  
Cordex 48-4kW/4.6kW



Figure 3 —  
Cordex 48-12kW

### 3. Specifications

<b>Table A — Rectifier Specifications</b>				
	<b>48-3.6kW</b>	<b>48-4kW</b>	<b>48-4.6kW</b>	<b>48-12kW</b>
<b>Electrical</b>				
<b>Input voltage</b>				
Nominal:	208, 220, 230, 240, 277Vac	208, 220, 230, 240, 277Vac	208, 220, 230, 240, 277Vac	208–240, 360–480, 280–277
Operating:	176 to 320Vac	187 to 320Vac	195 to 320Vac	187 to 320Vac
Extended:	176 to 305Vac (derated power)	187 to 305Vac (derated power)	195 to 305Vac (derated power)	187 to 305Vac (derated power)
<b>Maximum Input Voltage Phase Imbalance:</b>	10%	10%	10%	10%
<b>Input Frequency:</b>	45 to 66Hz	45 to 66Hz	45 to 66Hz	45 to 66Hz
<b>Input Current:</b>				
Nominal:	15A @ 277Vac 17A @ 240Vac 20A @ 208Vac	15A @ 277Vac 18A @ 240Vac 22A @ 208Vac	18A @ 277Vac 21A @ 240Vac 24A @ 208Vac	39-30A @ 208-240Vac 22-15A @ 360-480Vac 22-15A @ 208-277Vac
Max:	22.8A @ 176Vac	23.5A @ 176Vac	25.6A @ 195Vac	39A @ 208Vac
<b>Input Inrush Current</b>	≤ full load steady state current	≤ full load steady state current	≤ full load steady state current	≤ full load steady state current
<b>Input Leakage Current:</b>	<3.5mA @ 265Vac 60Hz	<3.5mA @ 265Vac 60Hz	<3.5mA @ 265Vac 60Hz	<3.5mA @ 265Vac 60Hz
<b>Start-up Ready Time:</b>	< 5 seconds (excluding soft start)	< 5 seconds (excluding soft start)	< 5 seconds (excluding soft start)	< 5 seconds (excluding soft start)
<b>Start-up Delay:</b>	≤ 120 second (programmable)	≤ 120 second (programmable)	≤ 120 second (programmable)	≤ 120 second (programmable)
<b>Soft Start:</b>	≤ 10 seconds (use adjustable, not including start-up)	≤ 10 seconds (use adjustable, not including start-up)	≤ 10 seconds (use adjustable, not including start-up)	≤ 8 seconds (use adjustable, not including start-up)
<b>Power Factor (50%-100% load):</b>	>0.99	>0.99	>0.99	>0.99
<b>Protection:</b>	10kA-interrupting capacity fuses in active and neutral lines			
<b>THD (50-100% load) Nominal Voltage:</b>	<5%	<13%	<11%	<13%
<b>Efficiency:</b>	>91% at nominal conditions and 50-100% load >92.8% peak	>93% at nominal conditions and 25 to 80% load >95% peak	>93% at nominal conditions and 25 to 80% load >95% peak	>94% at nominal conditions and 25-75% load >92.5% at nominal conditions and 100% load
<b>Holdup Time:</b>	>10ms	>9.6ms	>8ms	>9.5ms
<b>Temperature Stability:</b>	< 300 ppm/°C over the operating range			
<b>Output Voltage:</b>	42 to 60Vdc	42 to 60Vdc	42 to 60Vdc	44 to 60Vdc
<b>Maximum Output Current:</b>	66.5A @ 54Vdc nom (75A max @ 48V)	74A @ 54Vdc nom (83A max @ 48V)	85A @ 54Vdc nom (96A max @ 48V)	222A @ 54Vdc nom (249A max @ 48V)
<b>Maximum Power:</b>	3600W	4000W	4600W	12kW
<b>Static Load Regulation:</b>	Better than ±1%	Better than ±0.5%	Better than ±0.5%	Better than ±0.5%
<b>Dynamic Load Regulation (40-90% load step, output shall recover to static limits within 30ms):</b>	Better than ±2%	Better than ±2%	Better than ±4%	Better than ±2%

<b>Table A — Rectifier Specifications</b>				
	<b>48-3.6kW</b>	<b>48-4kW</b>	<b>48-4.6kW</b>	<b>48-12kW</b>
<b>Static Line Regulation:</b>	Better than ±1%	Better than ±1%	Better than ±1%	Better than ±1%
<b>Time Stability (per year, under control of CXC HP controller):</b>	≤0.5%	≤0.5%	≤0.5%	≤0.5%
<b>Electrical Noise:</b>				
Voice band:	<32dBmC	<38dBmC	<42dBmC	<38dBmC
Wide band:	<20mVrms (10kHz to 10MHz)	<20mVrms (10kHz to 10MHz)	<20mVrms (10kHz to 10MHz)	<20mVrms (10kHz to 10MHz)
	<100mVp-p (10kHz to 100MHz)	<150mVp-p (10kHz to 100MHz)	<100mVp-p (10kHz to 100MHz)	<150mVp-p (10kHz to 100MHz)
<b>Psophometric noise:</b>	<1.0mV RMS	<2.0mV RMS	<2.0mV RMS	<2.0mV RMS
<b>Acoustic noise:</b>	<64dBa	<60dBa	<64dBa	<60dBa
<b>Mechanical</b>				
<b>MTBF:</b>	> 391,000 hour ground benign @ 30°C (86°F)	> 479,000 hour ground benign @ 30°C (86°F)	> 479,000 hour ground benign @ 30°C (86°F)	> 160,000 hour ground benign @ 30°C (86°F)
<b>Dimensions H x W x D:</b>	177mm x 87mm x 326mm (7in x 3.4in x 12.8in)	177mm x 87mm x 331mm (7.0in x 3.4in x 13in)	177mm x 87mm x 331mm (7.0in x 3.4in x 13in)	177mm x 261mm x 365mm (7.0in x 10.3in x 14.38in)
<b>Weight:</b>	Module: 4.7kg (10.3lb) 23" Shelf: 14.5kg (32lb) 19" Shelf: 12.7kg (28lb)	Module: 3.9kg (8.6lb) 23" Shelf: 14.5kg (32lb) 19" Shelf: 12.7kg (28lb)	Module: 3.9kg (8.6lb) 23" Shelf: 14.5kg (32lb) 19" Shelf: 12.7kg (28lb)	Module: 12kg (27lb) 23" Shelf: 14.5kg (32lb) 19" Shelf: 12.7kg (28lb)
<b>Environmental</b>				
<b>Temperature:</b>				
Operation:	-40 to 75°C (-40 to 167°F)	-40 to 75°C (-40 to 167°F)	-40 to 75°C (-40 to 167°F)	-40 to 75°C (-40 to 167°F)
Full Nominal Output Power:	-40 to 65°C (-40 to 149°F)	-40 to 55°C (-40 to 131°F)	-40 to 40°C (-40 to 104°F)	-40 to 55°C (-40 to 131°F)
Storage:	-40 to 85°C (-40 to 185°F)	-40 to 85°C (-40 to 185°F)	-40 to 80°C (-40 to 176°F)	-40 to 85°C (-40 to 185°F)
<b>Humidity:</b>	0 to 95% non-condensing			
<b>Heat Dissipation:</b>	<1415BTU per hour	<1184BTU per hour	<1313BTU per hour	<3570BTU per hour
<b>Elevation:</b>	-500m to 2800m; to 4000m with temperature derated to 40°C (-1640ft to 9186ft; to 13124ft with temperature derated to 104°F)			
<b>Compliance</b>				
<b>Safety:</b>	2014/35/EU Low Voltage Directive CAN/CSA C22.2 No. 60950-1-07 + Am1:2011 +Am2:2014 ANSI/UL 60950-1-2014, Ed2 Telcordia (Bellcore) GR-1089-CORE (requirements applicable to rectifier)			
<b>EMC:</b>				
Emissions:	<b>3.6kW:</b> FCC Title 47 CFR Part 15/ICES-003 Issue 6 (Class B), EN 55022 Class B <b>4.0kW:</b> FCC Title 47 CFR Part 15/ICES-003 Issue 6 (Class B), EN 55032 Class B <b>4.6kW:</b> FCC Title 47 CFR Part 15/ICES-003 Issue 6 (Class A), EN 55032 Class A <b>12kW:</b> FCC Title 47 CFR Part 15/ICES-003 Issue 6 (Class A), EN 61000-6-3 Class A EN 61000-3-2 EN 61000-3-3			
Immunity:	<b>3.6kW:</b> ETSI EN 300 386 v1.3.1 <b>4.0kW:</b> ETSI EN 300 386 v1.6.1 <b>4.6kW:</b> ETSI EN 300 386 v1.6.1 <b>12kW:</b> IEC 61000-4-5, IEC 61000-4-12			

**Table A — Rectifier Specifications**

	<b>48-3.6kW</b>	<b>48-4kW</b>	<b>48-4.6kW</b>	<b>48-12kW</b>
<p>In accordance with FCC requirements, we provide the following statement as specified in the FCC guidelines for conformance to Part 15, <b>Class A</b>.</p> <p><b>NOTE:</b> This equipment has been tested and found to comply with the limits for a Class A digital device, pursuant to part 15 of the FCC Rules. These limits are designed to provide reasonable protection against harmful interference when the equipment is operated in a commercial environment. This equipment generates, uses, and can radiate radio frequency energy and, if not installed and used in accordance with the instruction manual, may cause harmful interference to radio communications. Operation of this equipment in a residential area is likely to cause harmful interference in which case the user will be required to correct the interference at his own expense.</p> <p>In accordance with FCC requirements, we provide the following statement as specified in the FCC guidelines for conformance to Part 15, <b>Class B</b>.</p> <p><b>NOTE:</b> This equipment has been tested and found to comply with the limits for a Class B digital device, pursuant to part 15 of the FCC Rules. These limits are designed to provide reasonable protection against harmful interference in a residential installation. This equipment generates, uses and can radiate radio frequency energy and, if not installed and used in accordance with the instructions, may cause harmful interference to radio communications. However, there is no guarantee that interference will not occur in a particular installation. If this equipment does cause harmful interference to radio or television reception, which can be determined by turning the equipment off and on, the user is encouraged to try to correct the interference by one or more of the following measures:</p> <ul style="list-style-type: none"><li>• Reorient or relocate the receiving antenna.</li><li>• Increase the separation between the equipment and receiver.</li><li>• Connect the equipment into an outlet on a circuit different from that to which the receiver is connected.</li><li>• Consult the dealer or an experienced radio/TV technician for help.</li></ul> <p>To comply with regulations in terms of radiated emissions, the CAN communication cable shall be wound in 3 loops around a ferrite p/n 417-401-10/19 (Fair-Rite p/n 0443167251), placed close to the socket in the shelf.</p> <p>Any changes or modifications to this equipment not expressly described in this manual could void the FCC compliance.</p>				

# 4. Features

## 4.1 Rectifier

The three LEDs on the rectifier front panel indicate status:

- AC ON (1)
- DC ON (2)
- Alarm (3)

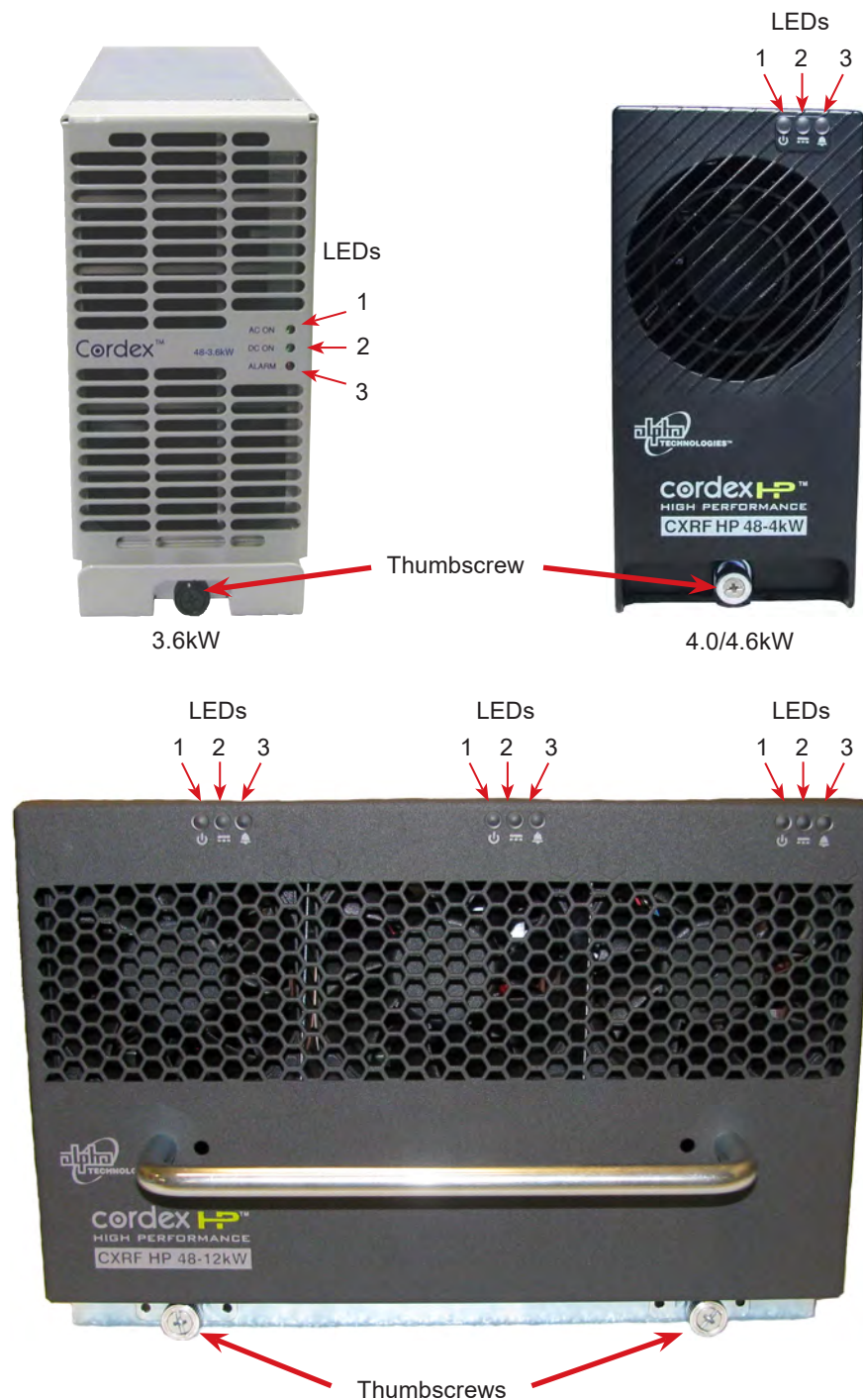

Figure 4 — Rectifier Front Panel LEDs

### 4.1.1 LEDs

The front panel LEDs indicate:

- Rectifier status summary
- Rectifier software upgrade in progress
- Patterned response to Locate Module command

The rectifier status summary shows the rectifier alarm status, communication fail status, and rectifier on/off status.

#### **AC ON (1)**

The green LED is illuminated when the AC input voltage is within its allowable range. The LED flashes (~2Hz) when input voltage is outside the allowable range. The AC input voltage is invalid if the AC Mains Low or AC Mains High alarm is active. This LED extinguishes if the AC input fails.

#### **DC ON (2)**

The green LED is illuminated when the rectifier is delivering power to the load. The LED flashes when communication is lost. The LED extinguishes when the rectifier is off, e.g., when commanded via the CXC.

#### **ALARM (3)**

The red LED is illuminated during an active Module Fail alarm if the module is unable to source power.

The LED flashes (~2Hz) when a minor alarm is detected if the modules output capability has been reduced or a minor component failure is detected.

The LED remains extinguished in the absence of an alarm.

#### **LED Activity During Firmware Upload**

When a rectifier firmware upload is in progress, the LEDs flash in a distinct pattern to indicate new rectifier firmware is being transferred from the controller. All three LEDs flash in a sequence lasting 1.5 seconds. When the last LED is lit, the sequence is repeated beginning at the first LED.

#### **LED Activity During the 'Locate Module' Command from the Controller**

When the "locate module" command has been received from the controller, the LEDs behave in a distinctly different way so that the rectifier is easier to visually identify among adjacent rectifiers.

This state is entered when commanded via the controller. The LEDs flash in a distinct pattern repeating every two seconds.

#### **Mechanical**

A thumbscrew is provided to secure the rectifier into the shelf. During normal operation the rectifier must be locked into position. A handle or grip on the front panel helps to remove the rectifier from the shelf. No special tools are required.

### 4.1.2 Rectifier Rear Panel

A single connector for shelf power and communications is located on the rear panel of each rectifier. The 12kW rectifier has three connectors.

### 4.1.3 True Module Fail Alarm

The power modules have a “true” fail alarm that provides a true indication of the power module’s ability to source current. When the module’s output current drops below 2.5% of the rated output, a low output current condition is detected and the Module Fail detection circuit is activated. This circuit momentarily ramps up the output voltage to determine if the module will source current. If no increase in current is detected, the Module Fail alarm is activated. The module will test once every 60 seconds for the condition until a current is detected. The output voltage ramping ceases upon detection of current. A minimum 2.5% load is required to avoid the Ramp Test Fail alarm. This can be provided with the parallel system battery. Activation of this alarm could indicate a failed module or a failed load.

For rectifier systems without batteries, or with a very light load below 2.5% of the rated output, the ramp test should be disabled to avoid nuisance alarms. The Ramp Test feature is enabled/disabled from the CXC Controller.

### 4.1.4 Heat Dissipation

Each rectifier module is equipped with at least one front-mounted fan. The fan runs when temperatures are above 0°C (32°F). The air flow is front-to-rear with the exhaust air exiting at the back. The fan is a variable speed fan; the speed is determined by the heatsink temperature and the load.

### 4.1.5 Over Temperature Protection

Component failure or a cooling airflow blockage can result in an excessive increase in temperature. During over-temperature conditions, the rectifier limits the output power and the output current. If the temperature continues to increase, the rectifier is shutdown. The rectifier restarts automatically when the temperature returns to a safe level.

### 4.1.6 Wide AC Range

A minor alarm is generated when the AC input voltage drops below its allowable limit.

#### 4.6kW

The rectifier output power is reduced linearly between 195Vac and 150Vac to 67% of the rated output power. The unit delivers derated output power down to 90Vac.

At 90Vac, the module shuts down and does not restart until the AC voltage is greater than or equal to 150Vac. The restart voltage depends on the load current. A reduced load current may allow a restart input voltage as low as 100Vac.

For voltages above 277Vac, the power factor and total harmonic distortion may be derated. Up to 305Vac, the rectifier will be operational and will not suffer any damage.

#### 4.0kW and 12kW

The rectifier output power is reduced linearly between 187Vac to 150Vac to 67% of the rated output power. The unit delivers derated output power down to 90Vac.

At 90Vac, the module shuts down and does not restart until the AC voltage is greater than or equal to 150Vac. The restart voltage depends on the load current. A reduced load current may allow a restart input voltage as low as 100Vac.

For voltages above 277Vac, the power factor and total harmonic distortion may be derated. Up to 305Vac, the rectifier will be operational and will not suffer any damage.

#### 3.6kW

Rectifier output power is reduced linearly between 176Vac and 150Vac to 75% of the rated output power (the unit will deliver derated output power down to 80Vac).

For voltages above 277Vac, the power factor and total harmonic distortion may be derated. Up to 305Vac, the rectifier will be operational and will not suffer any damage.

### 4.1.7 AC Inrush/Transient Suppression

To prevent a surge on the AC input line, the inrush current of a rectifier module is limited to the full load steady state line current. Modules are also protected from input lightning and transient surges in accordance with IEEE/ANSI C62.41 Category B3 standards.

### 4.1.8 Soft Start

A soft start feature is used to eliminate an instantaneous demand on the AC power source. A soft start, sometimes referred to as a “current walk-in”, works by gradually (up to ten seconds) ramping up the current limit from zero to the actual or defined customer setting. The rectifier output voltage is ramped from the minimum voltage to the float voltage.

### 4.1.9 Start Delay

The rectifier modules are equipped with a delay timer to stagger-start a series of modules to prevent excessive loading of generators upon start up. The built-in timer delays the switching on of the module by an interval (up to 120 seconds), which is set in the CXC. A minimum one-second delay is preset to allow the input capacitors to charge.

### 4.1.10 Current Limit/Short Circuit Protection

The current limit function determines the maximum output current limit of the rectifier module, regardless of the output voltage or power. The maximum output current is limited to a constant value down to a short circuit condition. Current limiting can be used to mate the rectifier output current ampacity to the needs of the load and parallel battery to minimize excessive battery recharge currents.

The rectifier will sustain a short circuit at the output terminals indefinitely. The maximum short circuit current will not exceed 105% of the rated full load current.

### 4.1.11 Power Limiting

Each rectifier module is designed to limit the power output to the module specification. This enables more current to be supplied at lower output voltages, and allows matching the output power to the demands of constant-power loads often seen in telecom equipment.

This feature may also be used for a faster recharge of flooded batteries paralleled with the load.



#### **NOTE:**

---

**The current limiting feature overrides the power-limiting feature.**

### 4.1.12 High Voltage Shutdown (HVSD)

This feature protects the load from over-voltages originating in the rectifiers. The offending rectifier module is shut down when a high output voltage condition occurs. The red Alarm (Module Fail) LED will illuminate. The module will restart automatically. However, if more than three over-voltage conditions occur within one minute, the module will latch off and remain shut down until it is reset.

### 4.1.13 Battery Eliminator Operation

Rectifier modules maintain all specifications (except where indicated) with or without a battery attached in parallel to the output. However, if a battery or another module supplying DC voltage in parallel is not present, there will be no monitoring or control activity during an AC power failure or input fuse failure.



## 4.2 Cordex® HP Controller (CXC HP)

The Cordex® HP (CXC HP) controller provides centralized setup, control and monitoring of power systems. This ranges from simple monitoring and threshold alarms for temperature, voltage and current, to advanced battery charging and diagnostic features.

The controller supports dual Ethernet ports and a 4.3" LCD screen to allow simultaneous network, LCD and local laptop access to the controller including both web and SNMP interfaces.

The controller supports to dual CAN ports to allow up to 256 power and/or ADIO modules to be controlled and monitored. The controller uses external analog and digital input and output (ADIO) peripherals to monitor electrical signals (temperature, voltage, temperature) and generate electrical signals through relays.

The most commonly used ADIO peripheral is the L-ADIO for low voltage systems which includes:

- 8 digital inputs
- 4 voltage sensors
- 4 temperature sensors
- 4 current sensors
- 12 Form C relay outputs

### 4.2.1 Controller Features

The controller has the following features:

- Front touchscreen: full color LCD touchscreen display, to access controls and menu items by using fingertip touch or a stylus.
- Home button: provides the ability to go directly back to the home screen from any menu.
- Front panel reset: for emergency use only to restart the controller if the unit touch screen or home button are not responding.
- Front panel LEDs: for alarms, progress and status indication.
- Audio speaker: built-in audio tones during active alarms, and can be disabled if required.
- Ethernet: dual ports 10/100 BaseT Ethernet connection on both the front and rear of the controller for remote or local communication.

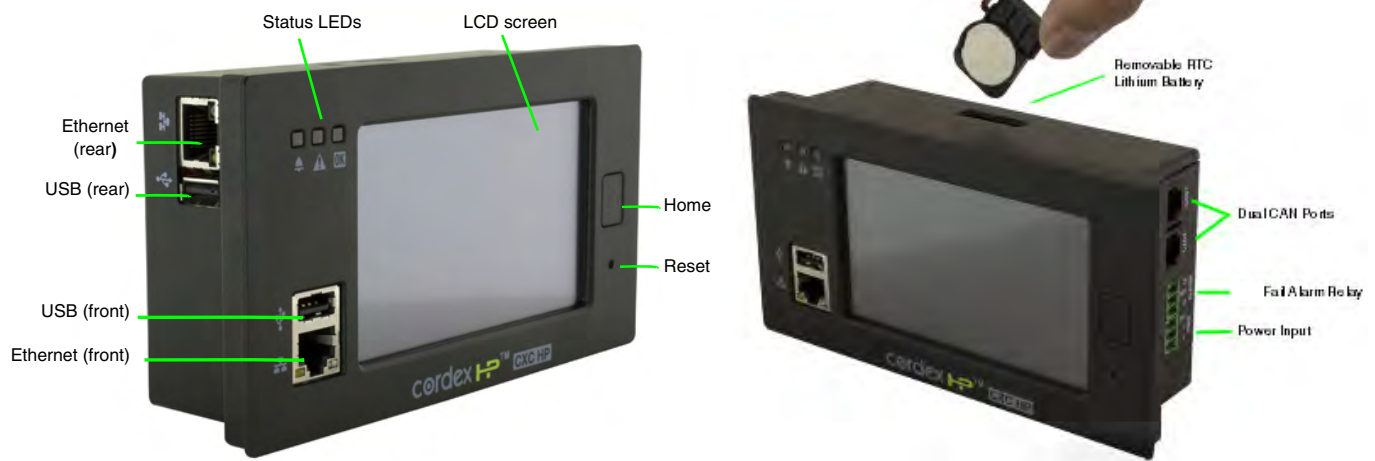

Figure 5 — Cordex® HP Controller (left and right side views)

- USB: dual ports on both the front and rear of the controller for upgrades and file management via a standard USB flash drive.
- CAN: dual independent CAN bus ports for communication with the Cordex and AMPS family of products, which allows for a greater number of devices.
- Real-time clock with field replaceable lithium battery: allows for timestamps on alarms and events.
- System fail alarm/relay: which activates when there is a major internal failure. During such a condition the unit attempts to reset.

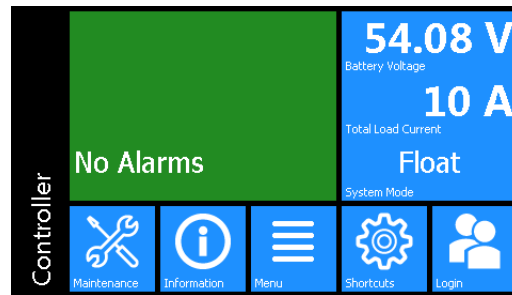

Figure 6 — LCD Color Touchscreen Display

# 5. Inspection

---

## 5.1 Packing Materials

All Alpha products are shipped in rugged, double walled boxes and suspended via solid inserts to minimize shock that may occur during transportation. Packaging assemblies and methods are tested to International Safe Transit Association standards.

Rectifiers and batteries are shipped on individual pallets and are packaged according to the manufacturer's guidelines.

### 5.1.1 Returns for Service

Save the original shipping container. If the product needs to be returned for service, it should be packaged in its original shipping container. If the original container is unavailable, make sure that the product is packed with at least three inches of shock-absorbing material to prevent shipping damage.

#### NOTE:

**Alpha Technologies is not responsible for damage caused by improper packaging of returned products.**

## 5.2 Check for Damage

Before unpacking the product, note any damage to the shipping container. Unpack the product and inspect the exterior for damage. If any damage is observed, contact the carrier immediately.

Continue the inspection for any internal damage. In the unlikely event of internal damage, inform the carrier and contact Alpha Technologies for advice on the impact of any damage.

## 5.3 General Receipt of Shipment

The inventory included with your shipment depends on the options you have ordered. The options are clearly marked on the shipping container labels and bill of materials.

### 5.3.1 Shelves

Consult the packing slip and power system bill of materials to verify that you have the correct number of shelves per your order.

### 5.3.2 Rectifiers (Purchased Separately)

Consult the packing slip to verify that you have received the correct number of rectifiers per your order.

### 5.3.3 Miscellaneous Small Parts

Review the packing slip and bill of materials to determine the part number of the "configuration kits" included with your system.

Review the bill of materials to verify that all the small parts are included.

# 6. Installation

---

The equipment is suitable for installation in Network Telecommunication Facilities.



## WARNING!

**This system is designed to be installed in a restricted access location that is inaccessible to the general public.**

The following procedure is written for qualified personnel to install this product in a clean and dry environment. For the battery installation, refer primarily to the manufacturer's manual.

### 6.1 Safety Precautions

Refer to the Safety section near the front of this manual before beginning this installation.

### 6.2 Tools Required

Various insulated tools are essential for the installation. Use this list as a guide:

- Battery lifting apparatus if required
- Electric drill with hammer action, 1/2" capacity
- Various crimping tools and dies to match lugs used in installation
- Load bank of sufficient capacity to load largest rectifier to its current limit
- Digital voltmeter equipped with test leads
- Cable cutters
- Torque wrench: 1/4" drive, 0 - 150 in-lb
- Torque wrench: 3/8" drive, 0 - 100 ft-lb
- Insulating canvases as required (2' x 2', 1' x 1', 3' x 3', etc.)
- Various insulated hand tools including:
  - Combination wrenches      - Ratchet and socket set
  - Various screwdrivers.              - Electricians knife
- Battery safety spill kit required for wet cells only:
  - Protective clothing              - Face shields
  - Gloves                              - Baking soda
  - Eye wash equipment
- Cutters and wire strippers (#14 to #22 AWG) [2.5 to 0.34 mm<sup>2</sup>]

## 6.3 Power System Assembly and Mounting

### 6.3.1 Shelf Preparation/Mounting

 **NOTE:**

---

**Mount the shelf in a clean and dry environment. Allow at least 1.75" of free space in front of the unit for unrestricted cooling airflow. Sufficient free space must be provided at the front and rear of the power system. This is to meet the cooling requirements of the rectifiers and to allow easy access to the power system components.**

The 19" shelf has been designed for flush mounting in a standard EIA relay rack. Options for mid-mounting in a 19" or 23" rack are also available. The 23" shelf can be flush or mid-mounted in a 23" relay rack.

Mounting brackets accommodate either 1" or 1-3/4" rack spacing. Mount the shelf to the rack using at least two #12 – 24 x 1/2" screws in each bracket. Use Phillips-type screws and screwdriver to eliminate the possibility of slippage and scratching of the unit's exterior.

An electrical conducting path must exist between the shelf chassis and the metalwork of the enclosure in which it is mounted or a grounding conductor. This electrical continuity requirement can be met by the use of thread-forming type unit mounting screws and star washers that remove any paint or non-conductive coatings and establish metal-to-metal contact.

### 6.3.2 Rack Mounted Systems

Attach the power system to the customer-provided relay rack using the mounting screws and star washers. Ensure a proper electrical bond between the system chassis and the relay rack.

### 6.3.3 Floor Mounted Systems

Secure the system to a concrete floor using either heavy duty anchors (1/2" x 2 1/2"), or for wooden floors, heavy-duty lag screws (5/8" x 2 1/2"). Use appropriately sized flat washers.

If required, use isolating kits to isolate system from the floor.

Secure the relay rack to the overhead cable tray. Alpha Technologies does not supply the mechanical details necessary for overhead support.

# 7. Wiring

This chapter provides cabling details and notes on cable sizing for DC applications using the Cordex 48-3.6kW, 4.0kW and 12kW modular switched mode rectifier systems.

Refer to the Safety section on page 5 for safety precautions.



## WARNING!

**Ensure that the power at the AC service panel is switched off. Remove battery line fuses or connections before attempting work on the wiring. Use a voltmeter to verify the absence of a voltage. Clearly mark the correct polarity of the battery leads before starting work on DC connections.**

## 7.1 Grounding

This power system is suitable for installation as part of a Common Bonding Network (CBN) and is intended to be used in a DC-C configuration (common DC return).

Connect the isolated power system battery return bus (BRB) to the building master ground bus (MGB), or floor ground bus (FGB) in a larger building. This acts as a system reference and as a low impedance path to the ground for surges, transients, noise, etc. The MGB or FGB must have a direct low impedance path to the building grounding system.

The cable from the power system to the MGB or FGB must be sized to provide sufficient ampacity to clear the largest fuse or breaker on the power system, excluding the battery protection fuse or circuit breaker. 750 MCM is recommended. This is the minimum requirement. Other factors including the length of the cable and special grounding requirements of the load must also be factored in. The insulated cable must be equipped with two-hole crimp type lugs and must not have any tight bends or kinks.

**Table B — Typical ground reference conductor selection**

Power system ampacity	Ground reference conductor size
< 30A	#10
30 – 100A	#6-2
100 – 400A	0000
400 – 800A	350 MCM
> 800A	750 MCM

The power system frame must also be connected to the MGB or FGB. This is done for personnel safety and to meet many telecom grounding requirements. Each bay must have its own frame or site ground connection. Refer also to the customer connections drawing at the rear of the manual.

## 7.2 AC Feeder Protection/Sizing

To maximize system reliability, each power module should be fed from a dedicated protection feeder breaker located at the AC distribution panel. The feeder breaker can also act as the disconnect device for the connected module. Refer to the specifications for recommendations.

## 7.3 AC Wiring



### CAUTION!

**To minimize EMI disturbances, route the AC input wires in flexible or rigid conduit and located as far away as possible from the DC power wires.**



### WARNING!

**Use care when removing or replacing the covers for the AC input connections. Never assume that an electrical connection or conductor is not energized.**

1. Ensure that all modules are removed from the shelf.
2. Remove the covers (two places) from the rear of the shelf to expose the AC input terminal blocks, L1 and L2 for each rectifier. (Refer to the customer connections drawing towards the end of the manual for AC terminal block location.) Each terminal pair corresponds to an individual power module as marked.
3. The wire way is designed for two customer-supplied, 1" conduit fittings for the AC supplies located on each side of the shelf. Attach the conduit retainers to the wire way hole(s) and route the AC cables through them.
4. Secure the wires to the AC input and chassis ground terminals.
5. Tighten the cable connector to the AC cable (conduit similar).
6. Replace rear cover(s) once all connections have been completed.

## 7.4 DC Wiring



### WARNING!

**Leave cables or bus bars disconnected at the battery and verify the output polarity using a voltmeter. Make battery connections only after all other wiring is completed.**

The DC output wires must be UL approved XHHW or RHH/RHW (RW90 type for Canadian users). Control and sense wires must be UL approved Style 1015 (TEW type for Canadian users).

The common output leg of the rectifier system must be connected to the ground. This is typically done at the load common termination point.

### 7.4.1 Terminating Cable Leads

Terminate cable leads with appropriate crimp lugs for 3/8" holes on 1" centers.

Secure the positive and negative to the shelf output post of the correct polarity; i.e., +V<sub>cable</sub> to +V<sub>post</sub>. Ensure the washers are on the bolts in the same order in which they were shipped from the factory. Tighten the bolts as per Customer Connections drawing at the rear of this manual.

### 7.4.2 Connecting to Busbar

Do not complete the final live connections to the battery. Leave open and insulate the final connections or remove the battery fuses. Switch off the battery contacts if used. Refer to the system startup procedure before connecting the batteries online.

Busbar adapters may be factory-installed, for the option selected, to easily accommodate direct connections to customers' vertical busbars.

Secure the positive and negative to the shelf output post of the correct polarity; i.e., +V<sub>cable</sub> to +V<sub>post</sub>. Ensure the washers are on the bolts in the same order in which they were shipped from the factory. Tighten the bolts as per Customer Connections drawing towards the end of this manual.

## 7.5 CAN Serial Ports

Each module communicates with the CXC HP controller using CAN protocol. The modules report alarms, rectifier output voltages, and the location of the module within a cabinet.

### 7.5.1 Making CAN Bus Connections

Figure 7 shows an example of a controller and three shelves.

1. Daisy chain the CAN bus cables from the controller to shelf #1, shelf #2 and then to the last shelf #3.
2. Insert the CAN terminator in the last shelf, as shown in Figure 7.

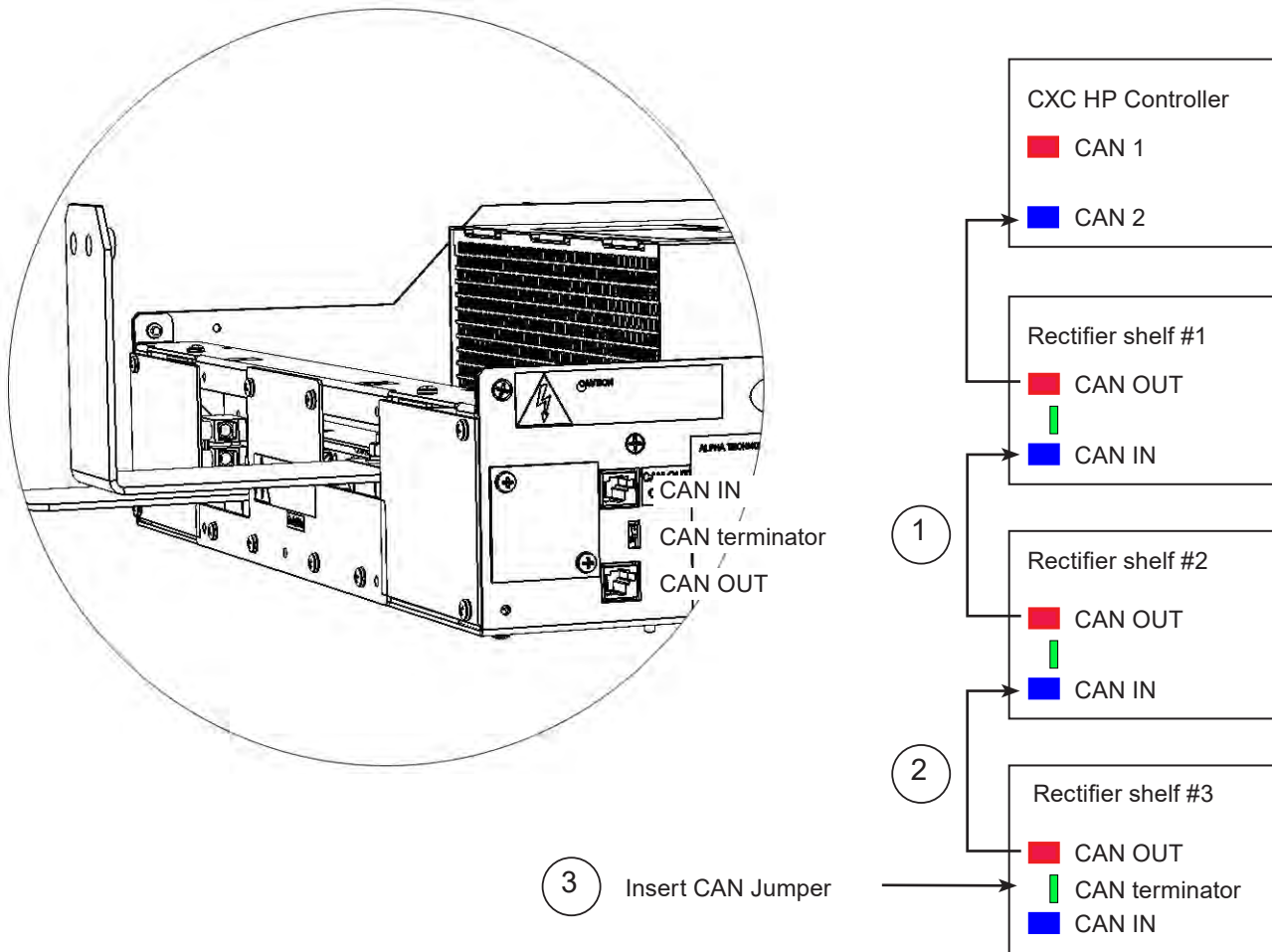

Figure 7 — CAN Port Connections



## 7.6 Shelf ID Connection

The shelf/bay ID comes factory installed on 4.6kW specific shelves and is only applicable to the 4.6kW rectifier. If shelves are installed in more than one bay, then set the Bay ID sequentially on each Shelf ID board.

Example of a single bay with two rectifier shelves.

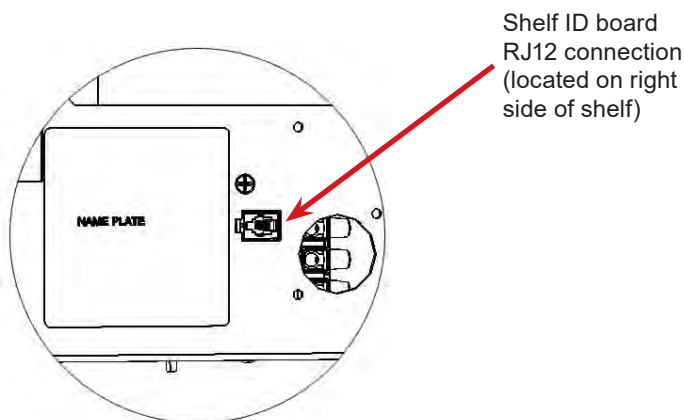
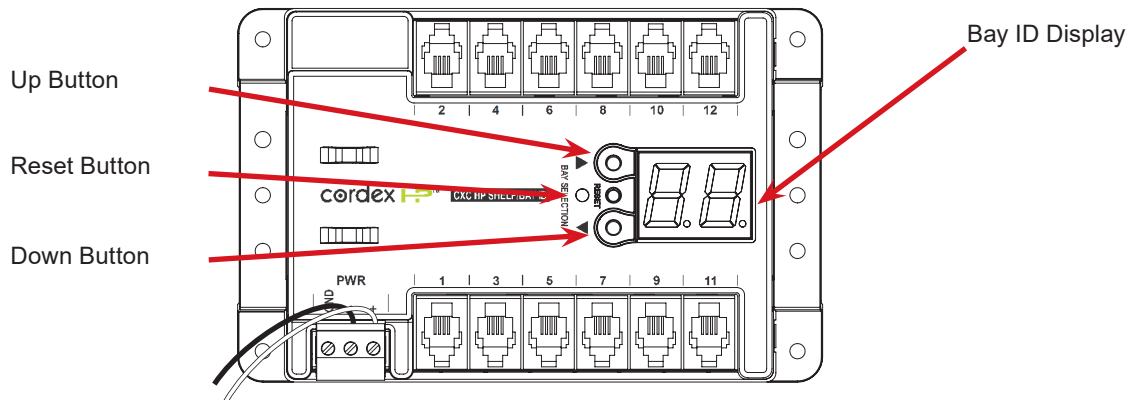
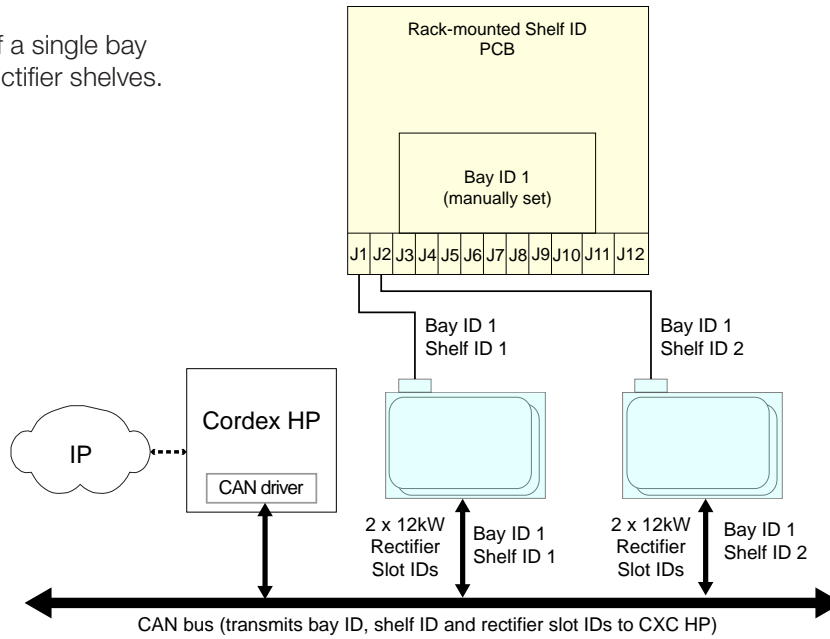

## 7.7 Signal Wiring Connections to L-ADIO Board

For terminal block connections, the recommended wire sizes are 0.823 to 0.129mm<sup>2</sup> (#18 to #26 AWG) for the temperature range of 0 to 50 deg. C (as per UL/CSA).



### CAUTION!

To reduce risk of fire, use only 0.129 mm<sup>2</sup> (#26 AWG) or larger wire.

### 7.7.1 Relay Outputs

Terminals provide contacts for extending various alarm or control signals. Each relay output can be wired for NO or NC operation during an alarm or control condition (4.1.1).

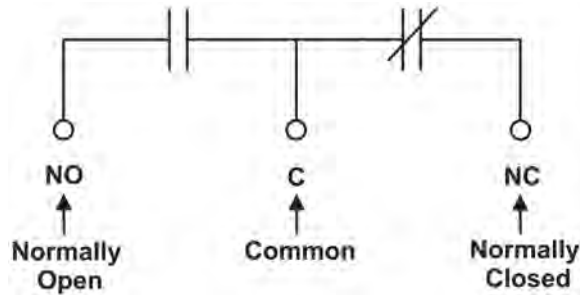

Figure 8 — Relay Connections in the De-energized State

Relays can be programmed to energize or de-energize during an alarm condition (see CXC-HP Software manual). When the CXC reset button is pressed or power is lost, all relays de-energize.

### 7.7.2 Digital Inputs

The digital input channels are used to monitor various alarm and control signals. All input channels are voltage activated and accept a bipolar (negative or positive) DC signal directly.

#### Connection Method

Typical systems use the “reset with Hot and trigger with Ground” connection. The digital input is wired in such a way that the Hot is wired directly into one of the input terminals. For example, the positive input for +24 V systems. The other input terminal is wired to the Ground (common) of the system through a dry contact relay usually located on the equipment requiring monitoring. This method allows the digital input to receive or not receive a Ground signal on an alarm.

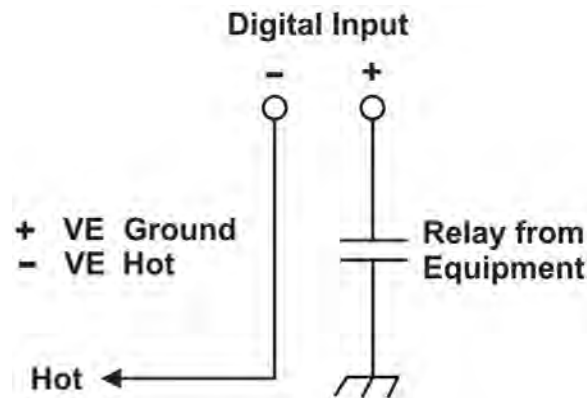

Figure 9 — Digital Input Connection Method

## Voltage level definitions for digital inputs

The digital input channels can be programmed for “active high” or “active low.” Active high indicates “alarm on the presence of a ground signal” and active low indicates “alarm on the removal of a ground signal.” See CXC HP Software manual for detailed instruction on programming.

Voltage Range (Vdc)	Voltage Level (Vdc) Considered As “0” (Off)	Voltage Level (Vdc) Considered As “1” (On)
0 – 60 +/- (system voltage setting)	-1 to +1*	(-60 to -5) or (+5 to +60)

\*NOTE: The range 1 – 5 +/- is undefined.

### 7.7.3 Analog Inputs



#### CAUTION!

**Ensure the correct polarity is used for all input cable terminations.**

The analog input channels are used to monitor various types of electrical signals. Some of the analog channels are reserved for specific signals, while others are designated as general-purpose inputs, which accommodate various types of analog signals.

The Battery -48V should be connected at the battery system voltage terminal for CXC HP reference when a battery disconnect device is used. It is critical to CXC HP operation as it ensures a source of power to the CXC HP should the disconnect device open the circuit.

#### Voltage

Voltage Input #1 (load voltage per CXC HP software) terminals (V1) on the shelf provide connections to an optional secondary voltage input. For example, this can be terminated to the load side of an LVD contactor to monitor load voltage.

Voltage Input #2 (battery voltage per CXC HP software) is wired internally (V2) to the rectifier output voltage of the shelf. This is used as the reference for system alarming (such as high voltage) and control (such as low voltage disconnect).

#### Temperature Sensing

Temperature Probe input channels provide connections for temperature sensors. A voltage is supplied to these terminals for sensor measurements.

#### Current

Current Input #1 (discharge or load current per CXC HP software) terminals (I1) are available for customer connection as required.

Current Input #2 (charge or battery current per CXC HP software) terminals (I2) are available for customer connection as required.

## 8. System Startup

---

Visually inspect the installation thoroughly.

After completing the system installation and power system wiring, perform the following startup and test procedure to ensure proper operation:

### 8.1 Check System Connections

1. Make sure that the AC input power is switched off, the batteries are disconnected, and all the power modules are removed from the shelf.
2. Triple-check the polarity of all connections.

### 8.2 Verify AC and Power the Rectifier Shelf

#### NOTE:

**Insert the first module into the front left most position using the side of the shelf as a guide. Subsequent modules can be inserted using the previous module as a guide.**

**Do not force a module into position if it does not seat properly. All modules are keyed to ensure that the correct module (voltage/polarity) type is used.**

1. Install one power module.
  - a. Place the rectifier module on the shelf bottom and slide the module into the rear connector (inside the shelf).
  - b. Apply pressure on the module handle to engage the rear connector in the shelf receptacle.
  - c. Tighten the screw on the bottom of the faceplate to secure the module to the shelf.
2. Verify that the AC input voltage is correct and switch on the corresponding feeder breaker. The power module **AC ON** LED illuminates after a preset start delay. (See 4.1.1 for a description of the LEDs.)
3. Using the controller, test the functionality of various module alarms and controls.

### 8.3 Triple Check Battery Polarity and Connections

1. Use a voltmeter to verify that the battery polarity is correct. Ensure that no cells or batteries are reversed.
2. Connect the batteries to the output of the system.
3. Install the remaining power modules.
4. In the adjustments menu of the controller, set the float and equalize voltages to the levels specified by the battery manufacturer.
5. Using the controller, test the functionality of the various module alarms and controls. Perform a load test with the system using a resistive load box.
6. Enable the temperature compensation (temp comp) feature in the batteries menu. Program the settings for slope and breakpoints (upper and lower) according to the specific batteries used.

### 8.4 CXC HP Reset

Use the LCD on the front panel of the optional CXC HP to restart the microprocessor. Click **Settings** (Gear symbol) and then **Reset**. See Figure 6.

# 9. Operation

---

## 9.1 Main Rectifier States

Rectifier operation has five main states; each state is distinct and necessary for the operation of the rectifier.

- Off
- Start Delay
- Soft Start
- Normal Operation
- Turning Off

### 9.1.1 Off

The rectifier is in the Off state immediately after power is applied to the rectifier or after a rectifier shutdown (remote or local shutdown, AC shutdown, OVP or thermal shutdown).

In this state the DC-DC converter is turned off and the controller monitors its inputs for the proper conditions to begin the start up sequence.

When the conditions have been met for start up, the rectifier transitions to the Start Delay state.

### 9.1.2 Start Delay

When the rectifier is in the Start Delay state, the DC-DC converter is held off and still not sourcing power, waiting for a given amount of time before transitioning to the next state.

The controller continues to monitor its inputs.

After the Start Delay state, the rectifier transitions to the Soft Start state.

**NOTE:** Soft start, or current walk-in, gradually increases the voltage and current output of the rectifier upon startup. This is done to reduce the instantaneous load on the AC source.

### 9.1.3 Soft Start

When the Soft Start state is entered, the rectifier is turned on and the output voltage and output current gradually increased. If a load is present, the rectifier begins to source power.

When the voltage and current limit ramps have finished, the rectifier will transition to the Normal Operation state.

### 9.1.4 Normal Operation

The Normal Operation state is the state that the rectifier will be in performing all of the rectifier functions and features specified herein.

From this state, the only valid transition is to the Turning Off state. This transition will happen if the rectifier is required to shut down.

### 9.1.5 Turning Off

The Turning Off state is entered because a short delay is required before the rectifier actually turns off to take care of any initialization requirements.

When this short delay has elapsed, a transition to the Off state is made.

## 9.2 Main Rectifier Modes

In addition to the main rectifier states, there is a set of main rectifier modes. These modes can be divided into two categories, the output voltage mode and the output current/power mode.

## 9.2.1 Output Voltage Modes

Voltage modes can be thought of as modes that, under software control, can directly adjust the output voltage. The qualification of “under software control” is made because there are processes that occur in the rectifier that can change the output voltage that do not adjust the output voltage directly, for example, if the rectifier has reached the current limit.

Table C lists four output voltage modes and a description of when they are active.

<b>Table C — Output voltage modes</b>	
<b>Output Voltage Modes</b>	<b>Active when...</b>
Float	Output voltage is set to the float voltage setting.
Equalize	Output voltage is set to the equalize voltage setting.
Battery Test	Output voltage is set to the battery test voltage setting.
Safe	Output voltage is set to the safe mode voltage setting.
Manual Test	Output voltage can be manually adjusted outside of the standard adjustment ranges.

## 9.2.2 Output Current/Power Modes

These modes directly affect the output current and power. Table D lists the four output current/power modes and a description of when they are active.

<b>Table D — Output current/power modes</b>	
<b>Output Voltage Modes</b>	<b>Active when...</b>
Temperature foldback mode	Output current and power limit have been reduced because a high temperature has been detected on the heatsink or internal ambient temperature sensor.
AC foldback mode	Output current and power limits have been reduced because the AC input voltage is low. This will reduce the risk of tripping an AC breaker due to increased AC current draw as the AC voltage decreases.
Short circuit foldback mode	Output current limit has been reduced due to a short circuit at the output.
Internal fault foldback mode	Output current limit has been reduced due to an internal fault.

### 9.3 Factory Ranges and Defaults

Table E shows the rectifier settings/ranges/defaults. Changes are made from the controller.

<b>Table E — Rectifier factory ranges and defaults</b>		
<b>Setting</b>	<b>Range (minimum to maximum)</b>	<b>Default</b>
Float (FL) Voltage	47.5 – 58.2V	54V
Equalize (EQ) Voltage	49.8 – 60.2V	55V
Battery Test (BT) Voltage	44 – 52V	46V
Over Voltage Protection (OVP)*	63V	57V
Current Limit (CL)	23 – 100%	100%
Power Limit (PL)	0 – 100%	100%
Module Start Delay	0 – 250s	1s
System Start Delay	0 – 600s	0s
Low Voltage Alarm (LVA)	42 – 52V	44V
High Voltage Alarm (HVA)	52 – 63V	55.5V
EQ Timeout	1 – 2399h	30h
BT Timeout	1 – 250h	8h
Softstart Ramp-rate	Normal/Fast	Normal
CL/PL Alarm	Enable/Disable	Enable
Remote Shutdown	Enable/Disable	Enable
Ramp Test	Enable/Disable	Enable

\*The OVP cannot be set below the present system/FL/EQ/BT voltage setting or the safe mode voltage of 51.0V.

# 10. Maintenance

Although very little maintenance is required with our systems, routine checks and adjustments are recommended to ensure optimum system performance. Qualified service personnel should do the repairs.

The following table lists a few maintenance procedures for this system. These procedures should be performed at least once a year.



## WARNING!

**Use extreme care when working inside the unit while the system is energized. Do not make contact with live components or parts.**



**Circuit cards, including RAM chips, can be damaged by static electricity. Always wear a grounded wrist strap when handling or installing circuit cards.**

**Ensure redundant modules or batteries are used to eliminate the threat of service interruptions while performing maintenance on the system's alarms and control settings.**

**Table F — Sample maintenance log**

Procedure	Date Completed
Clean ventilation openings.	
Inspect all system connections. Re-torque if necessary.	
Verify alarm/control settings.	
Verify alarm relay operation.	

## 10.1 Replacing a Rectifier Module

The Cordex® Rectifier (CXR) series modules are plug and play. When a rectifier module is added to the system, the controller will detect and update the inventory automatically. Replacing an installed rectifier requires a manual Inventory Update at the controller to clear the removed rectifier from its current list of rectifiers.

- To remove a module, loosen the screw on the bottom of the faceplate. Grasp the handle and pull it out, sliding the module away from the rear connector and out of the shelf.
- At the controller LCD, initiate an Inventory Update as follows (or **Main Menu > Rectifiers > Inventory Update** for the web interface):

Tap the Rectifier icon on the controller home page.

Tap Inventory Update.

A pop-up window appears with a progress bar showing the number of modules acquired during the update.

Inventory Update clears the current list of rectifiers and re-acquires all connected modules.

- Place the new rectifier module on the shelf bottom and slide the module into the rear connector (inside the shelf). Apply pressure on the module handle to engage the rear connector in the shelf receptacle.
- Tighten the screw on the bottom of the faceplate to secure the module to the shelf.



## 10.2 Fan and Fan Filter Replacement

### 10.2.1 4.0kW/4.6kW Rectifier Fan Replacement

Part number: 747-679-20-000



1. Switch off the unit and unscrew the front fastener that secures the power module to the shelf.
2. Slide the module 10cm (4") out of the shelf and wait ten minutes for the module capacitors to discharge.
3. Remove the three screws that secure the front panel to the module chassis. Slide the front panel out.

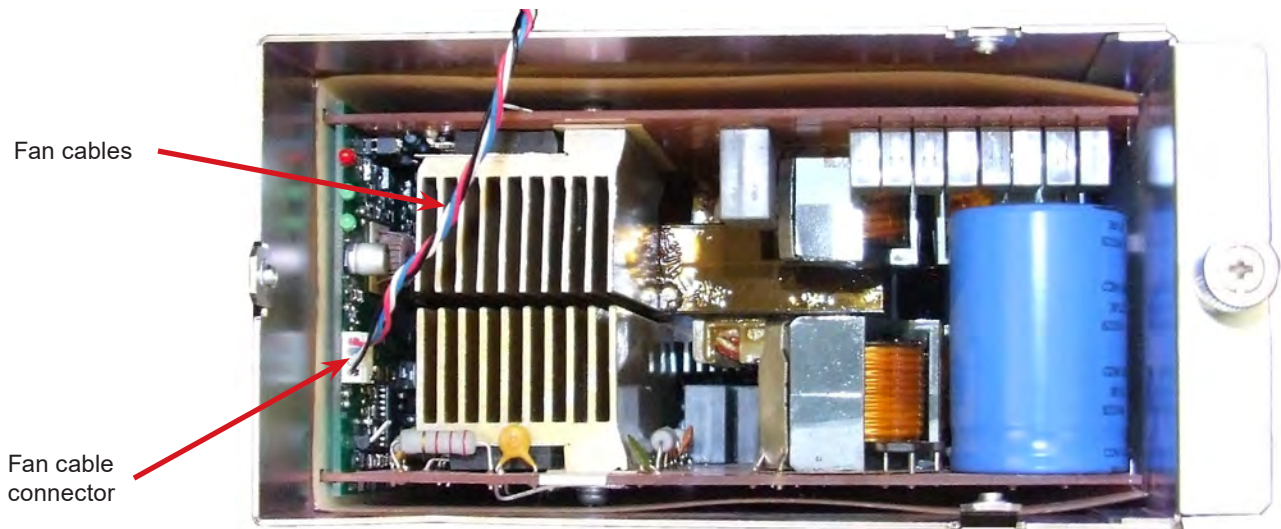

4. Disconnect the fan cables from the module by pulling out the fan cable connector.
5. Remove the two screws that secure the fan to the front panel.
6. Note the direction of the airflow and remove the fan from the front panel.

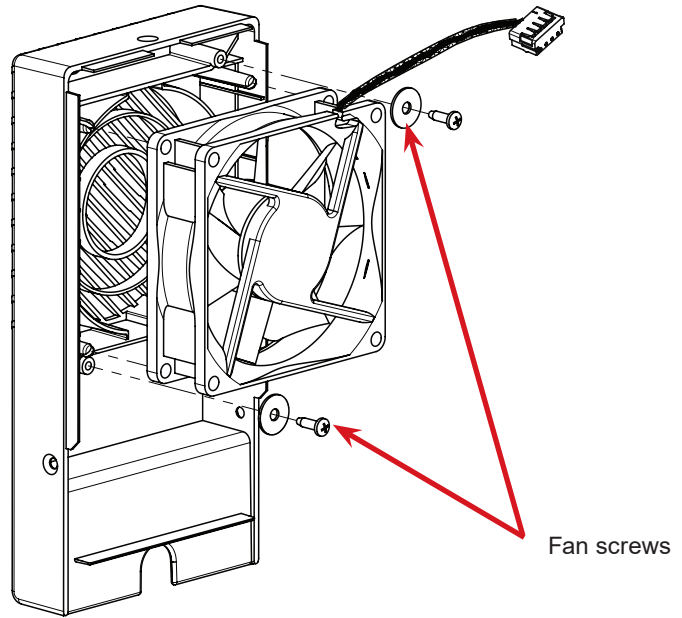

Figure 10 — 4kW/4.6kW Rectifier Fan Removal

7. Install the replacement fan following the preceding steps in reverse order.

## 10.2.2 12kW Rectifier Fan Replacement

Part number: 747-679-20-000

1. Switch off the unit and unscrew the front fastener that secures the power module to the shelf.
2. Remove the eight screws shown in Figure 11.

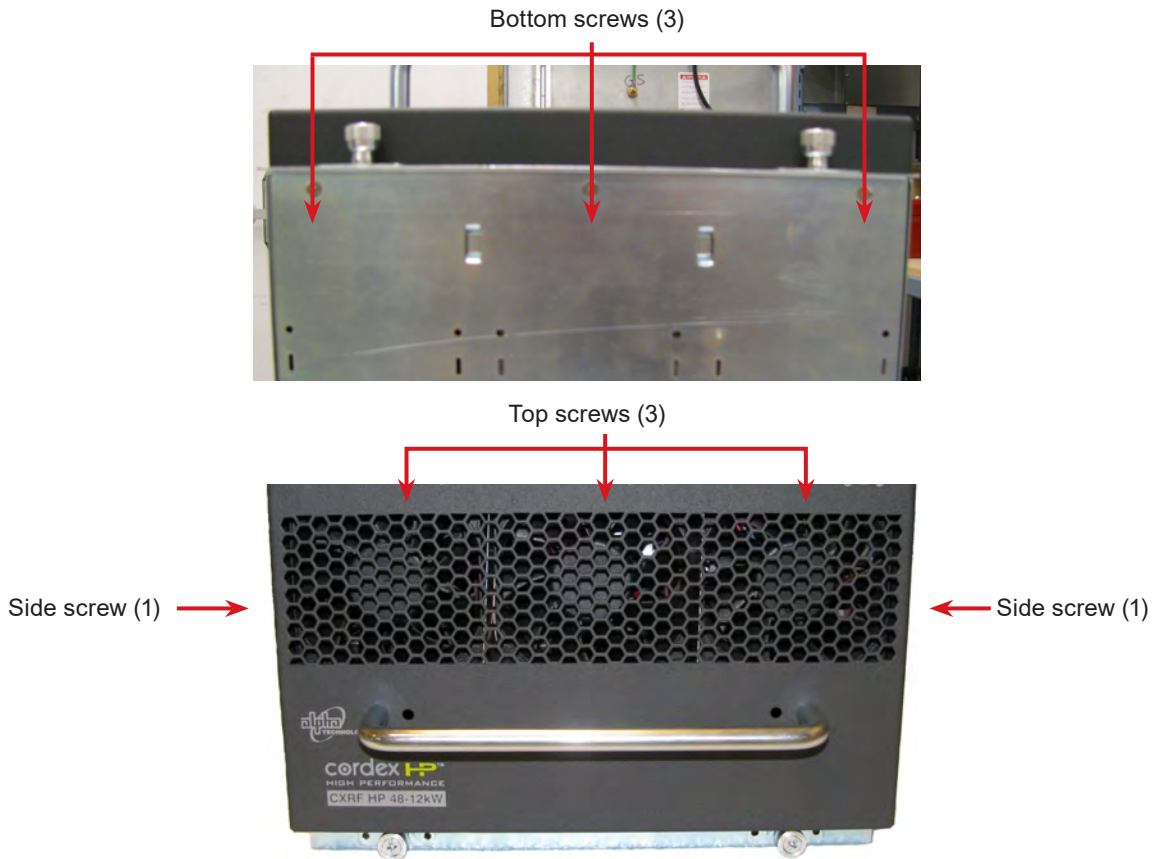

Figure 11 — Fan Assembly - Screw Removal

3. Disconnect the fan cables and remove the fan assembly from the rectifier.

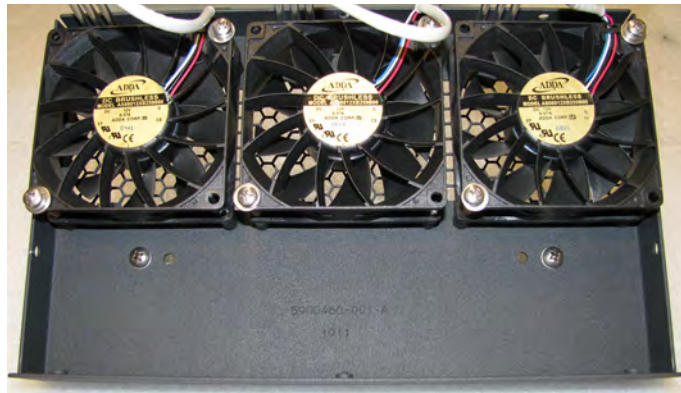
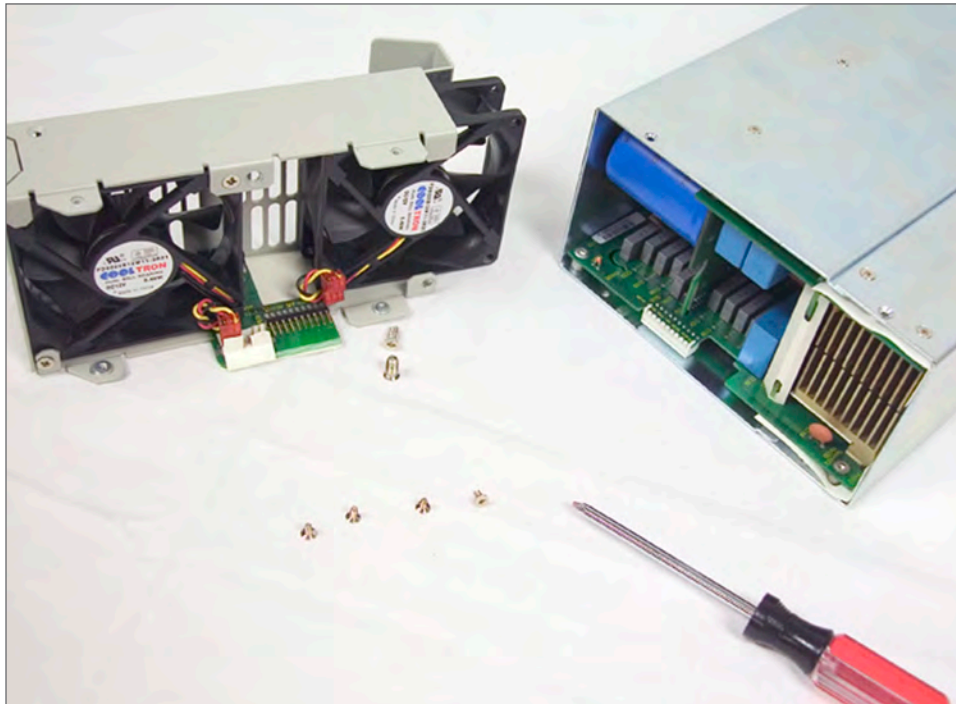

Figure 12 — Fan Assembly Removal

4. Remove the two screws that secure the failed fan to the panel.
5. Note the direction of the airflow and remove the fan.
6. Install the replacement fans following the preceding steps in reverse order.

### 10.2.3 3.6kW Rectifier Fan or Filter Replacement

Part number: 707-359-20-000



1. Shut off the unit and unscrew the front fastener that secures the power module to the shelf.
2. Slide the module 10cm (4") out of the shelf and wait two minutes for module capacitors to discharge.
3. Remove the four screws (two each side) that secure the front panel to the module chassis.
4. Slide the front panel out.
5. Disconnect the fan power lead wires (one set per fan) and front panel ribbon cable from the module.
6. Remove the screws that secure the fans to the front panel.
7. Note the direction of airflow and remove the fans (or filters) from the front panel.
8. Install the replacement fans (or filters) following the preceding steps in reverse order.

## 10.3 MOV Replacement

### 10.3.1 4.0kW Rectifier MOV Replacement

Part number: 707-813-20-000

The MOVs (metal oxide varistor) are used to protect the power modules from power line surges and surges caused by lightning strikes. High capacity surges may permanently damage MOVs but they are easily replaced in the field using the following procedure:

1. Shut off the unit and unscrew the front fastener that secures the power module to the shelf.
2. Slide the module 10cm (4") out of the shelf and wait ten minutes for the module capacitors to discharge.

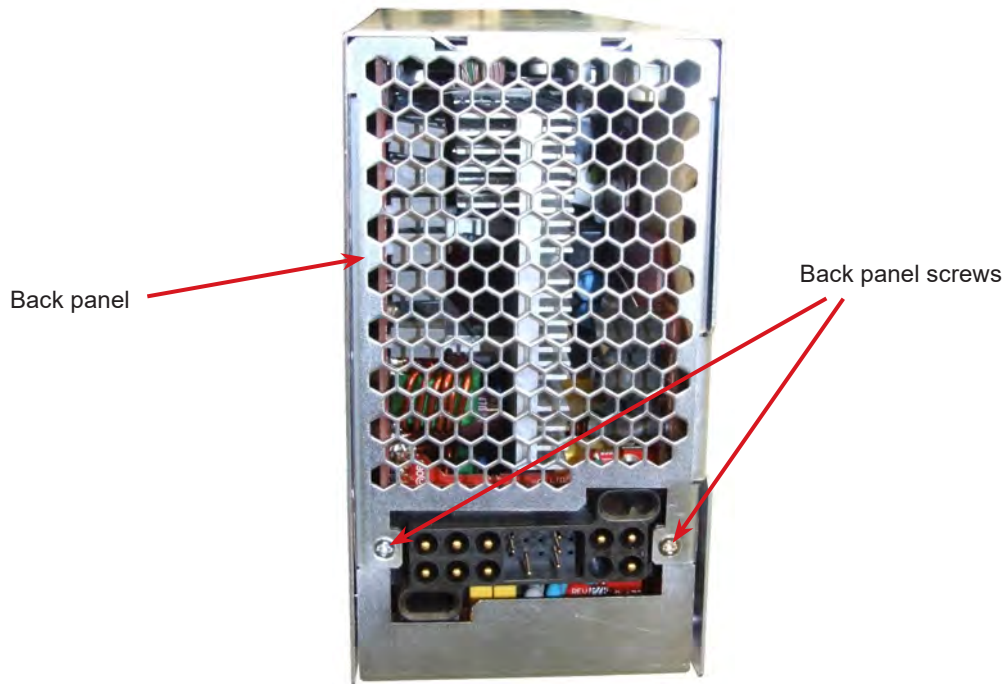

3. Remove the two screws that secure the back panel to the module.

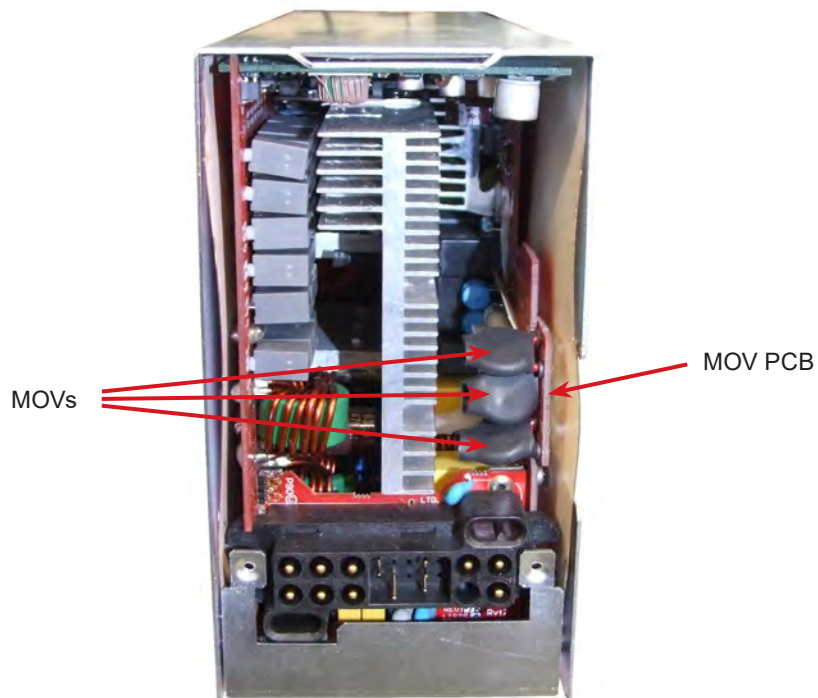

4. Remove the cover and find the MOV printed circuit board (PCB).

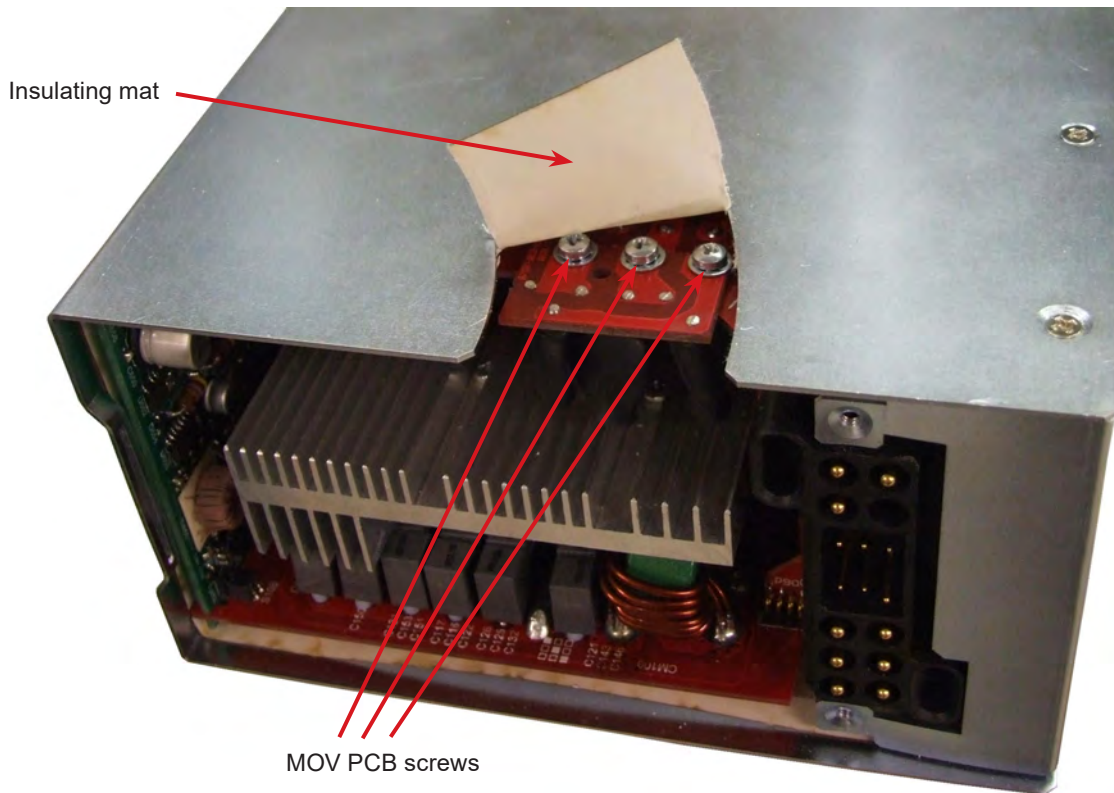

5. Fold the insulating mat out of the way and remove the three screws that secure the MOV PCB to the module.

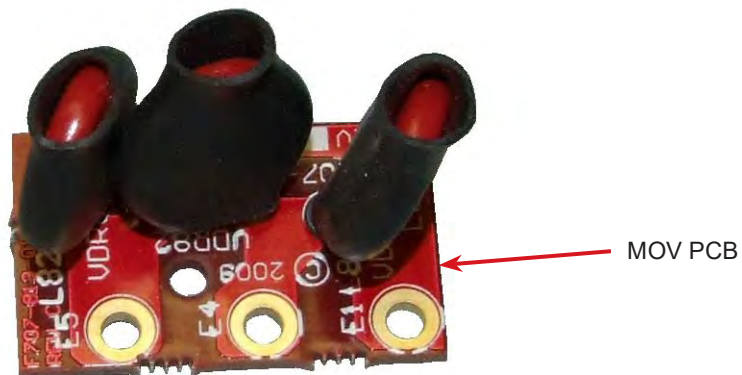

6. Remove the MOV PCB.
7. Decontaminate the area and unit with a flux remover or similar cleaning compound. This is done to remove any metallic particles or carbon that may have been deposited when the MOV failed.
8. Install the replacement MOV PCB following the preceding steps in reverse order.

### 10.3.2 12kW Rectifier MOV Replacement

Part number: 707-813-20-000

The MOVs (metal oxide varistor) are used to protect the power modules from power line surges and surges caused by lightning strikes. High capacity surges may permanently damage MOVs but they are easily replaced in the field using the following procedure:

1. Shut off the unit and unscrew the front fastener that secures the 12kW power module to the shelf.
2. Slide the module out of the shelf and wait ten minutes for the module capacitors to discharge.
3. Remove the six screws that secure the back panel to the module.
4. Slide the back panel downwards to release it from the top of the chassis.

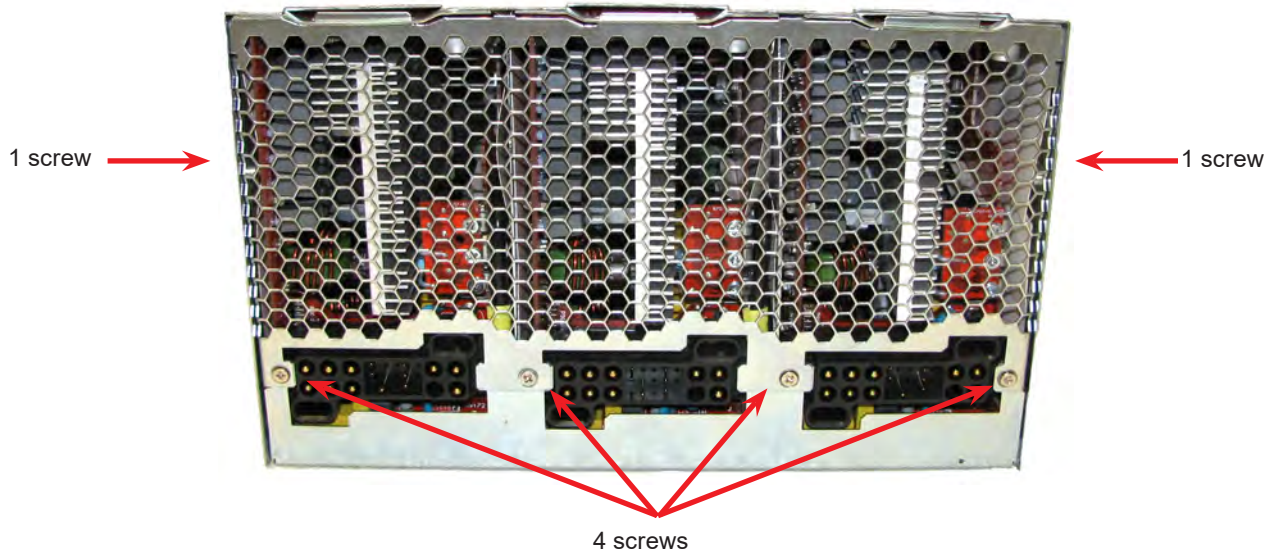

5. Unscrew and remove the defective MOV board.

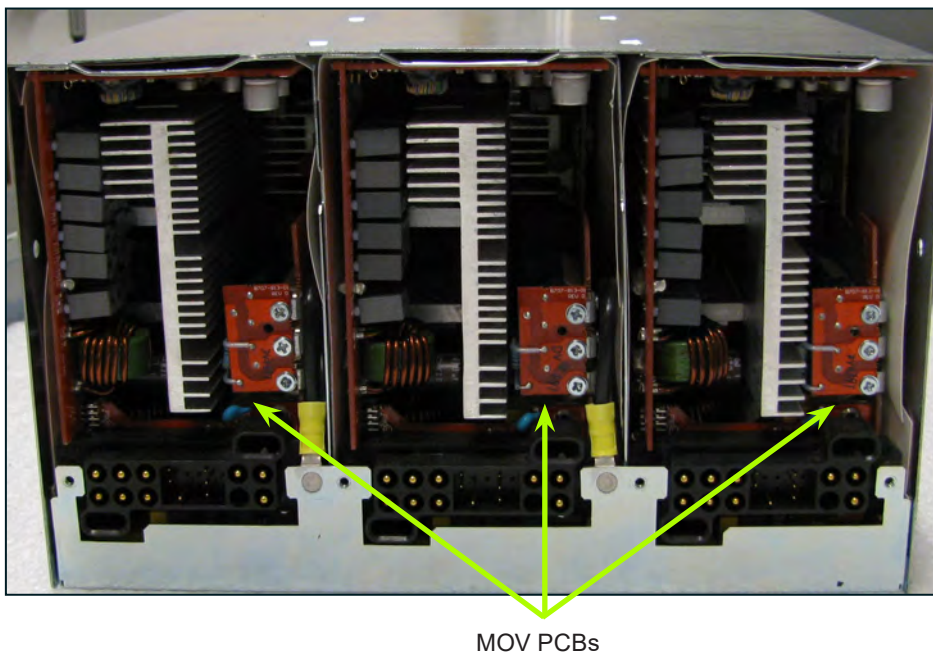

6. Decontaminate the area and unit with a flux remover or similar cleaning compound. This is done to remove any metallic particles or carbon that may have been deposited when the MOV failed.
7. Install the replacement MOV PCB following the preceding steps in reverse order.

### 10.3.3 3.6kW Rectifier MOV Replacement

Part number: 707-813-20-080

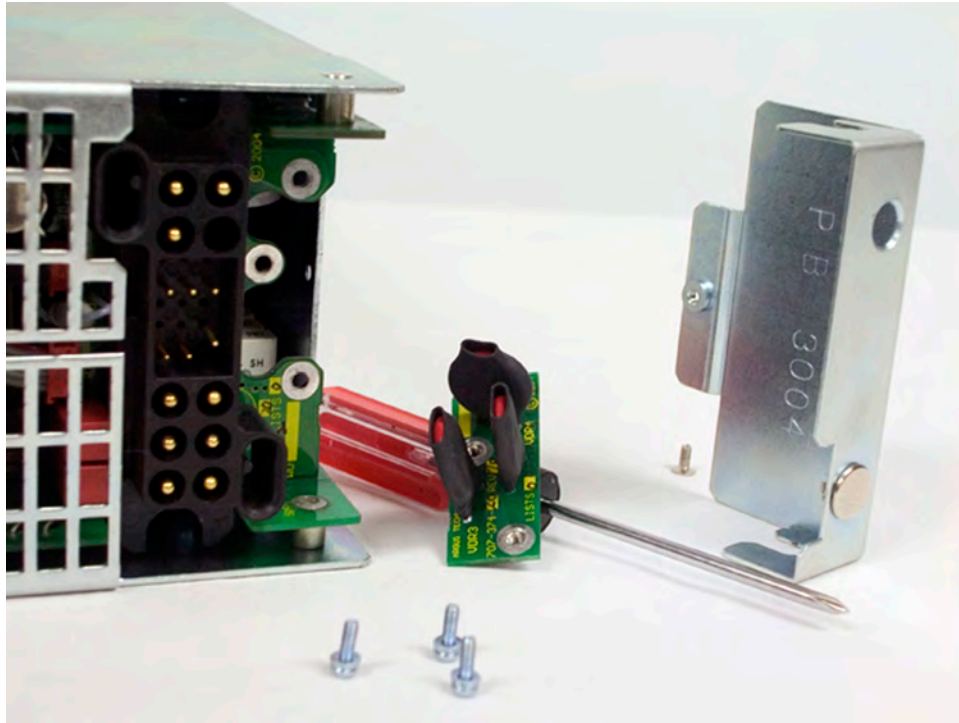

The MOVs (metal oxide varistor) are used to protect the power modules from power line surges and the surges caused by lightning strikes. High capacity surges may permanently damage MOVs but they are easily replaced in the field using the following procedure:

1. Shut off the unit and unscrew the front fastener that secures the power module to the shelf.
2. Slide the module 10 cm (4") out of the shelf and wait two minutes for module capacitors to discharge.
3. Turn the module around to face the back of the unit and remove the one screw (module bottom toward the rear) securing the MOV cover.
4. Remove the cover and locate the MOV printed circuit board (PCB).
5. Remove the three screws that secure the MOV PCB.
6. Decontaminate the area and unit with flux remover or a similar cleaning compound. This is to remove any metallic particles or carbon, which may have been deposited when the MOV failed.
7. Install the replacement MOV PCB following the preceding steps in reverse order.



# 11. Acronyms and Definitions

AC	Alternating current
ANSI	American National Standards Institute
AWG	American Wire Gauge
BTU	British thermal unit
CAN	Controller area network
CEC	Canadian Electrical Code
CSA	Canadian Standards Association
CX	Cordex® series; e.g., CXC for Cordex System Controller
DC	Direct current
DHCP	Dynamic Host Configuration Protocol
EIA	Electronic Industries Alliance
EMC	Electromagnetic compatibility
EMI	Electromagnetic interference
ERM	Electromagnetic Compatibility and Radio Spectrum Matters
ESD	Electrostatic Discharge
FCC	Federal Communications Commission (for the USA)
GSM	Group Speciale Mobile (global system for mobile communications)
HVSD	High voltage shutdown
IEC	International Electrotechnical Commission
IEEE	Institute of Electrical and Electronics Engineers
IP	Internet Protocol
LED	Light emitting diode
LVD	Low voltage disconnect
MIL	One thousandth of an inch; used in expressing wire cross sectional area
MOV	Metal oxide varistor
MTBF	Mean time between failures
NC	Normally closed
NEC	National Electrical Code (for the USA)
NO	Normally open
OSHA	Occupational Safety & Health Administration
OVP	Over voltage protection
RAM	Random access memory
RU	Rack unit (1.75")
TCP/IP	Transmission Control Protocol / Internet Protocol
THD	Total harmonic distortion
UL	Underwriters Laboratories
VRLA	Valve regulated lead acid

# 12. Warranty and Service Information

---

## 12.1 Technical Support

In Canada and the USA, call toll free 1-888-462-7487.

Customers outside Canada and the USA, call +1-604-436-5547.

## 12.2 Warranty Statement

For full information details review Alpha's online Warranty Statement at [www.alpha.ca/support](http://www.alpha.ca/support).

## 12.3 Product Warranty

Alpha warrants that for a period of two (2) years from the date of shipment its products shall be free from defects under normal authorized use consistent with the product specifications and Alpha's instructions, the terms of the manual will take precedence.

The warranty provides for repairing, replacing or issuing credit (at Alpha's discretion) for any equipment manufactured by it and returned by the customer to the factory or other authorized location during the warranty period.

There are limitations to this warranty coverage. The warranty does not provide to the customer or other parties any remedies other than the above. It does not provide coverage for any loss of profits, loss of use, costs for removal or installation of defective equipment, damages or consequential damages based upon equipment failure during or after the warranty period. No other obligations are expressed or implied. Warranty also does not cover damage or equipment failure due to cause(s) external to the unit including, but not limited to, environmental conditions, water damage, power surges or any other external influence.

The customer is responsible for all shipping and handling charges. Where products are covered under warranty Alpha will pay the cost of shipping the repaired or replacement unit back to the customer.

## 12.4 Battery Warranty

Note that battery warranty terms and conditions vary by battery and by intended use. Contact your Alpha sales representative or the Technical Support team at the above number to understand your entitlements under Battery Warranty.

## 12.5 Warranty Claims

Any claim under this Limited Warranty must be made in writing to Alpha BEFORE sending material back. Alpha will provide Product return instructions upon approval of return request. A Service Repair Order (SRO) and / or Return Authorization (RA) number will be issued ensuring that your service needs are handled promptly and efficiently.

Claims must be made online at: [www.alpha.ca](http://www.alpha.ca).

## 12.6 Service Information

For a list of international service centers, refer to the Alpha website: [www.alpha.ca](http://www.alpha.ca)

# 13. Certification

## About CSA and UL

CSA (Canadian Standards Association also known as CSA Group) was established in 1919 as an independent testing laboratory in Canada. CSA received its recognition as an NRTL (Nationally Recognized Testing Laboratory) in 1992 from OSHA (Occupational Safety and Health Administration) in the United States of America (Docket No. NRTL-2-92).

When these marks appear with the indicator “C and US” it means that the product is certified for both the US and Canadian markets, to the applicable US and Canadian standards. (1)

As part of the reciprocal, US/Canada agreement regarding testing laboratories, the Standards Council of Canada (Canada’s national accreditation body) granted Underwriters Laboratories (UL) authority to certify products for sale in Canada. (2)

Only Underwriters Laboratories may grant a licence for the use of this mark, which indicates compliance with both Canadian and US requirements. (3)



## NRTLs Capabilities

NRTLs are third party organizations recognized by OSHA, US Department of Labor, under the NRTL program.

The testing and certifications are based on product safety standards developed by US based standards developing organizations and are often issued by the American National Standards Institute (ANSI). (4)

The NRTL determines that a product meets the requirements of an appropriate consensus-based product safety standard either by successfully testing the product itself, or by verifying that a contract laboratory has done so, and the NRTL certifies that the product meets the requirements of the product safety standard. (4)

## Governance of NRTL

The NRTL Program is both national and international in scope with foreign labs permitted.

- (1) [www.csagroup.org](http://www.csagroup.org)
- (2) [www.scc.ca](http://www.scc.ca)
- (3) [www.ulc.ca](http://www.ulc.ca)
- (4) [www.osha.gov](http://www.osha.gov)

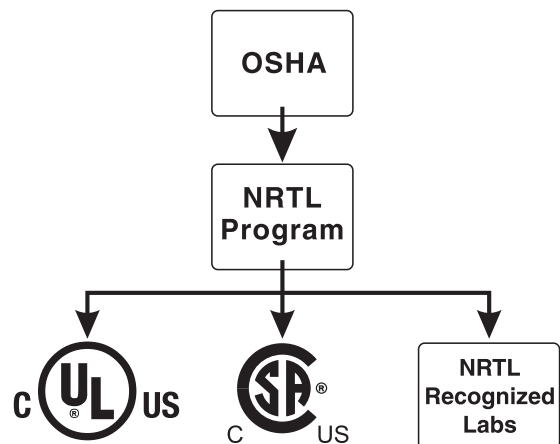

**23" 4KW RECTIFIER SHELF - LIST 85: 208-277 VAC SINGLE PHASE AC INPUTS**

REVISIONS			
ITER	DESCRIPTION	DRW	DATE

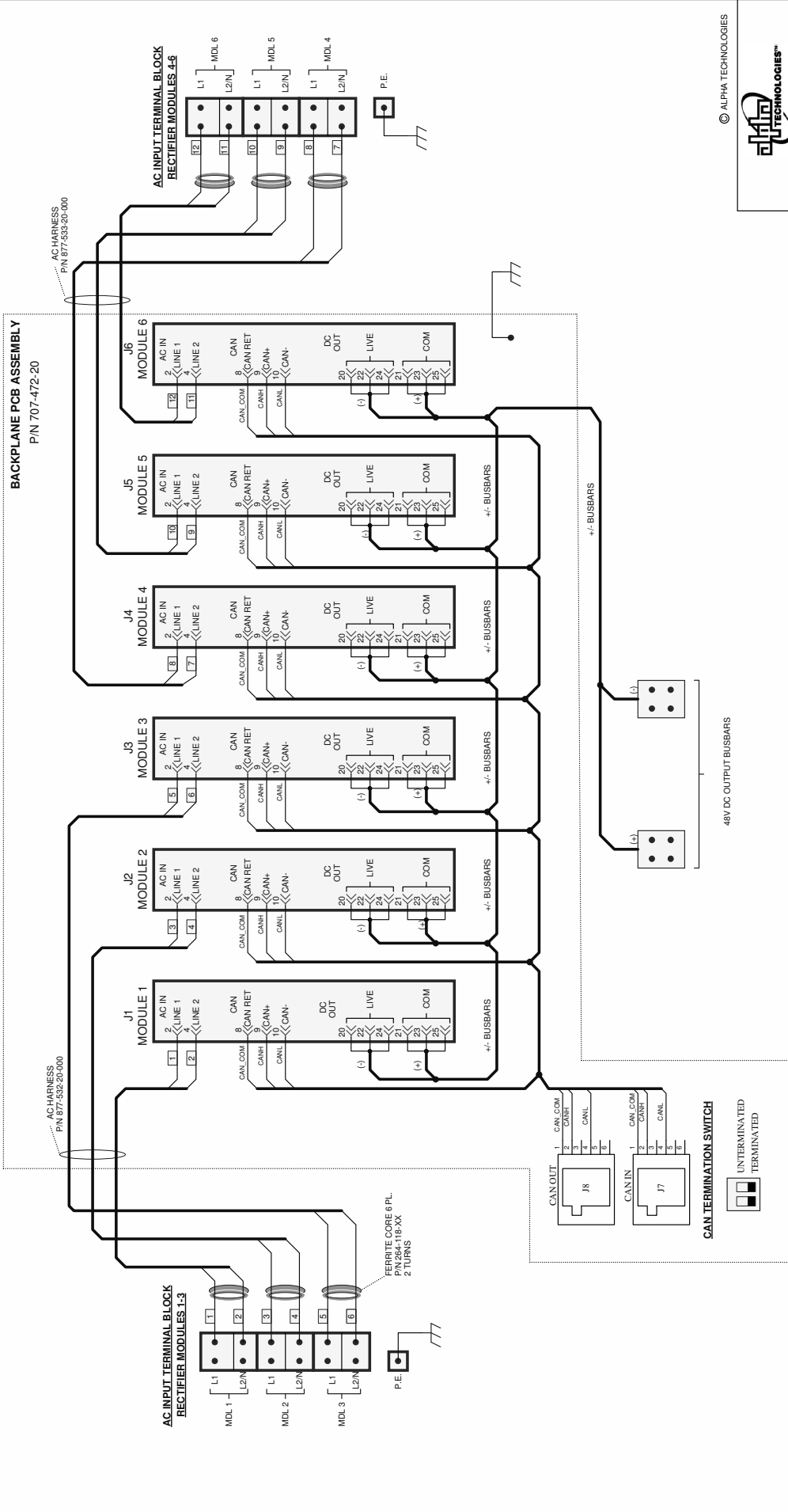

© ALPHA TECHNOLOGIES

THESE DESIGNS AND SPECIFICATIONS ARE CONFIDENTIAL AND NOT BE LOANED, REPRODUCED, COPIED, OR USED IN ANY MANNER WITHOUT THE WRITTEN CONSENT OF ALPHA TECHNOLOGIES.

DESIGN	J/K	201709	CHECKED	BJ	201711
DRAWN	J/K	201709	APPROVED	JK	201711

TITLE: SCHEMATIC, CXRF 48-4KW  
23" SHELF

DATE	SHEET	1 of 3
SIZE	TYPE	DWG NO.
B	S5	030-716-05
REV	A	

**23" 4KW RECTIFIER SHELF - LIST 83: 208-240 VAC DUAL 3-PHASE INPUT (NO NEUTRAL)**

**BACKPLANE PCB ASSEMBLY**  
PIN 707-472-20

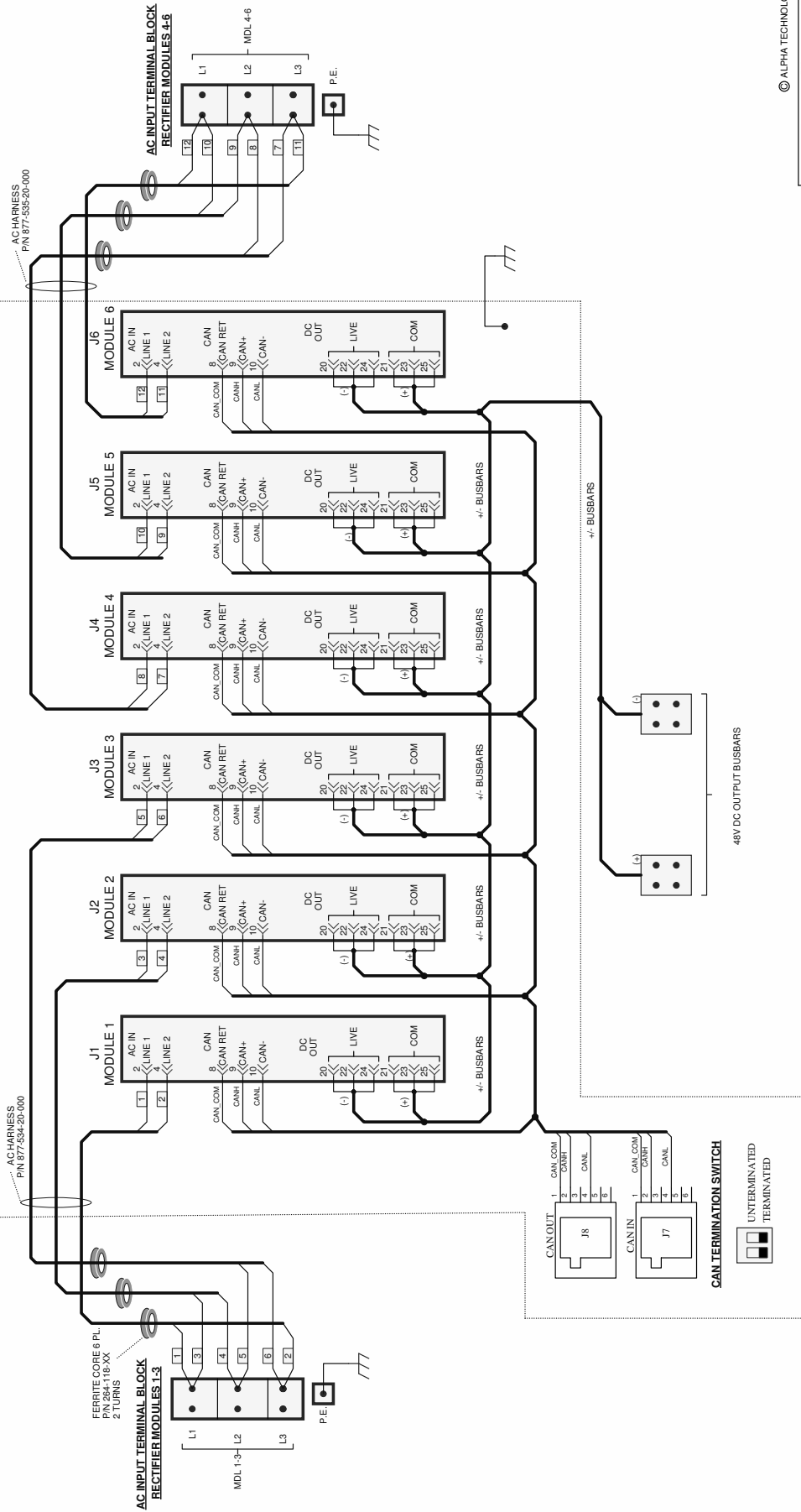

© ALPHA TECHNOLOGIES



THESE DESIGNS AND SPECIFICATIONS ARE CONFIDENTIAL AND NOT BE COPIED OR USED WITHOUT ITS WRITTEN CONSENT.  
TITLE

**SCHEMATIC, CXRF 48-4KW  
23" SHELF VERSION**

ISSUE	SHEET 2 of 3	REV	A
DATE	B	SS	
TYPE	DWGNO.	030-716-05	

**23" 4KW RECTIFIER SHELF - LIST 84: 360-480 VAC,DUAL 3PH 1/P (WYE SOURCE, NEUTRAL REQUIRED)**

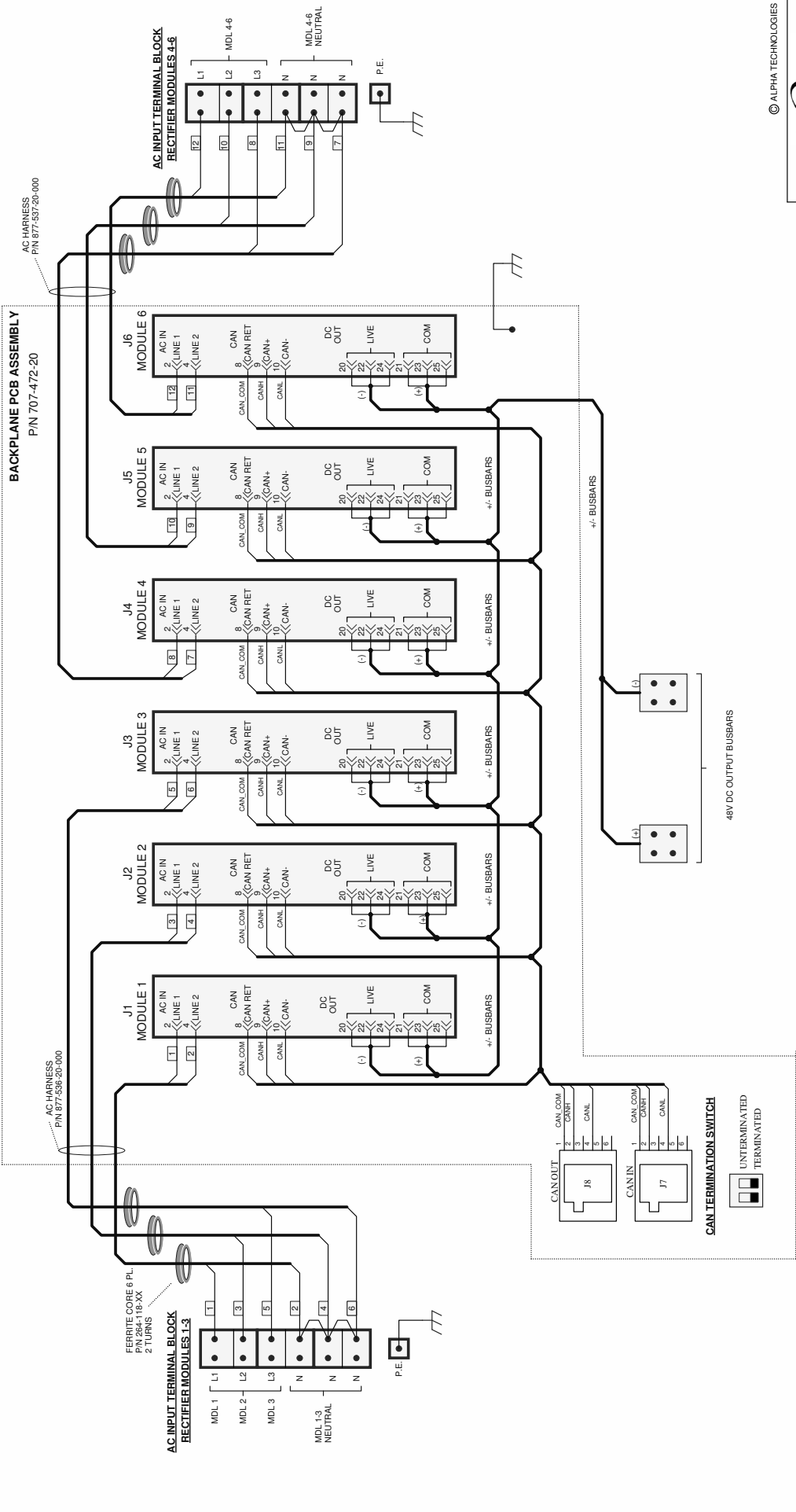

© ALPHA TECHNOLOGIES



THESE DESIGNS AND SPECIFICATIONS ARE CONFIDENTIAL AND NOT BE COPIED OR USED WITHOUT ITS WRITTEN CONSENT.  
TITLE

SCHEMATIC, CXRF 48-4KW  
23" SHELF VERSION

ISSUE	SHEET 3 of 3	REV	A
DATE	B	SIZE	SS
TYPE	DWGNO.	030-716-05	

REVISIONS	
TR	DESCRIPTION
1	CORRECTED NO. OF MODULES
2	INCORPORATED EOB-A1-A9
3	LIST 81 UPDATED
4	CORRECTED VIEWS DESCRIPTION
5	REVISED FOR SOLIDWORKS INTEGRATION

DATE	BY	CHKD	APP'D
05/10/10	WES		
05/10/10	WES		
05/10/10	WES		
12/10/10	SY		

DO NOT SCALE DRAWING

REAR ISOMETRIC VIEW

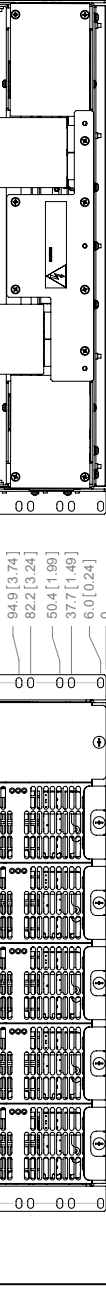
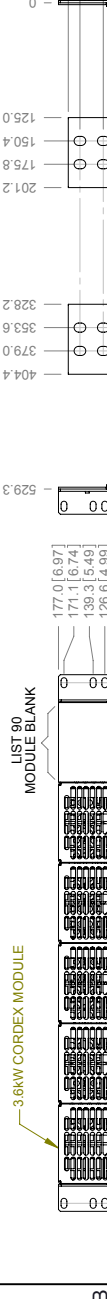
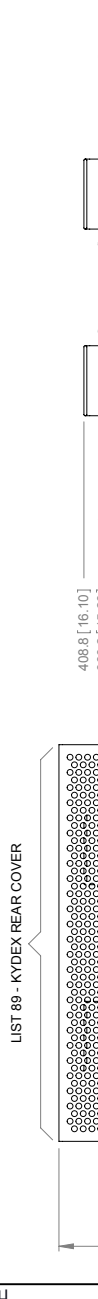

UNLESS OTHERWISE SPECIFIED DIM ARE IN MM	
X	+0.5
X.X	+0.25
X.XX	+0.1
ANGULAR: ±1°	
INTERSECTING DIM AND TOL PER ASME Y14.5M 2009	
THIRD ANGLE PROJECTION	

APPROVALS		DATE	
DRAWN	EOF	MAR-04	MAR-04
CHECKED	WS	MAR-04	

© ALPHA TECHNOLOGIES LTD	
SCALE:	NTS
SHEET	1 OF 2

TITLE: OUTLINE, 23" SHELF, 3.6KW CORDEX	
SIZE	DWG NO. 030-716-06
REV	F
REV	1 OF 2



1

2

3

4

5

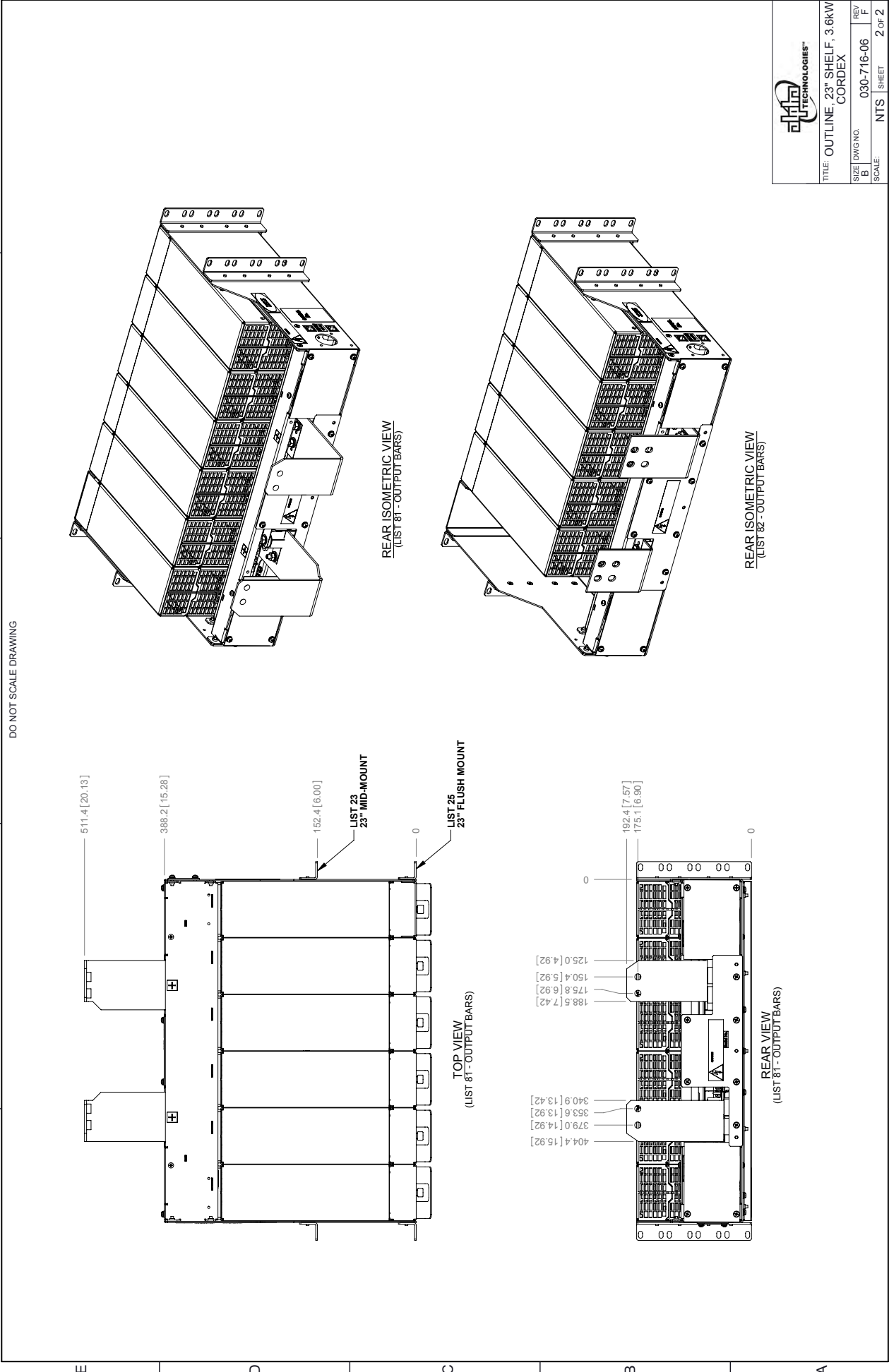

E

D

C

B

A

E

D

C

B

A



TITLE: OUTLINE, 23" SHELF, 3.6KW  
CORDEX

SIZE	DWG NO.	REV
B	030-716-06	F
SCALE:	NTS	SHEET
		2 OF 2

1

2

3

4

5



DO NOT SCALE DRAWING

REVISIONS			
LTR	DESCRIPTION	DWN	CHK
B	LIST B1 UPDATED	MP/UJ	WES
C	CORRECTED VIEW DESCRIPTIONS	MP	GS
D	UPDATED LIST B5 LABELS	SDW	GIA
E	REVISED FOR SOLIDWORKS INTEGRATION	JL	SY
F	ADDED NOTE TO DETAIL A	JMAR	SP

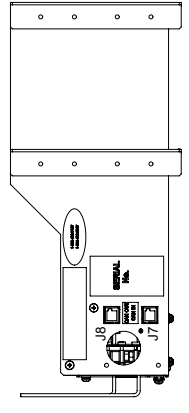
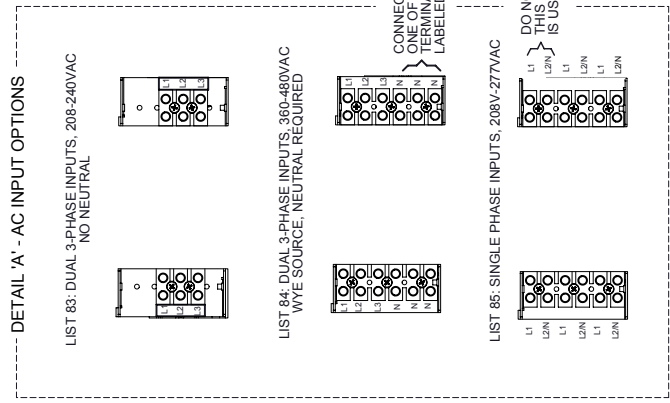
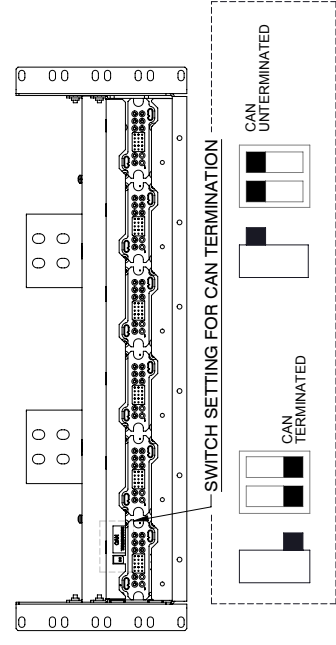
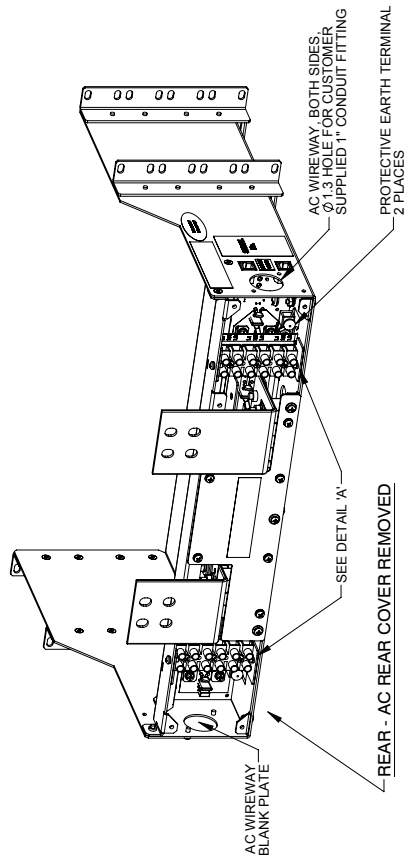

CAN OUT RJ12 OFFSET  
PIN OUT (J8)

1. GND
2. CAN H
3. NOT CONNECTED
4. CAN L
5. NOT CONNECTED
6. NOT CONNECTED

CAN IN RJ12 OFFSET  
PIN OUT (J7)

1. GND
2. CAN H
3. NOT CONNECTED
4. CAN L
5. NOT CONNECTED
6. NOT CONNECTED

UNLESS OTHERWISE SPECIFIED  
DIM ARE IN INCHES  
X.X .0005  
X.XX ±0.020  
X.XXX ±0.010  
ANGULAR ±1°  
INTERSECT DIM AND TOL PER ASME Y14.5  
THIRD ANGLE PROJECTION

APPROVALS  
DRAWN: F6601005  
CHECKED: JK Mar/01/05  
DATE: Mar/01/05

© ALPHA TECHNOLOGIES LTD  
SCALE: N.T.S. SHEET 1 OF 2

ALPHA TECHNOLOGIES

TITLE: CUSTOMER CONNECTION  
23" SHELF, 3.6KW CORDEX

SIZE DWG NO. 030-716-08  
REV F  
REV 1 OF 2

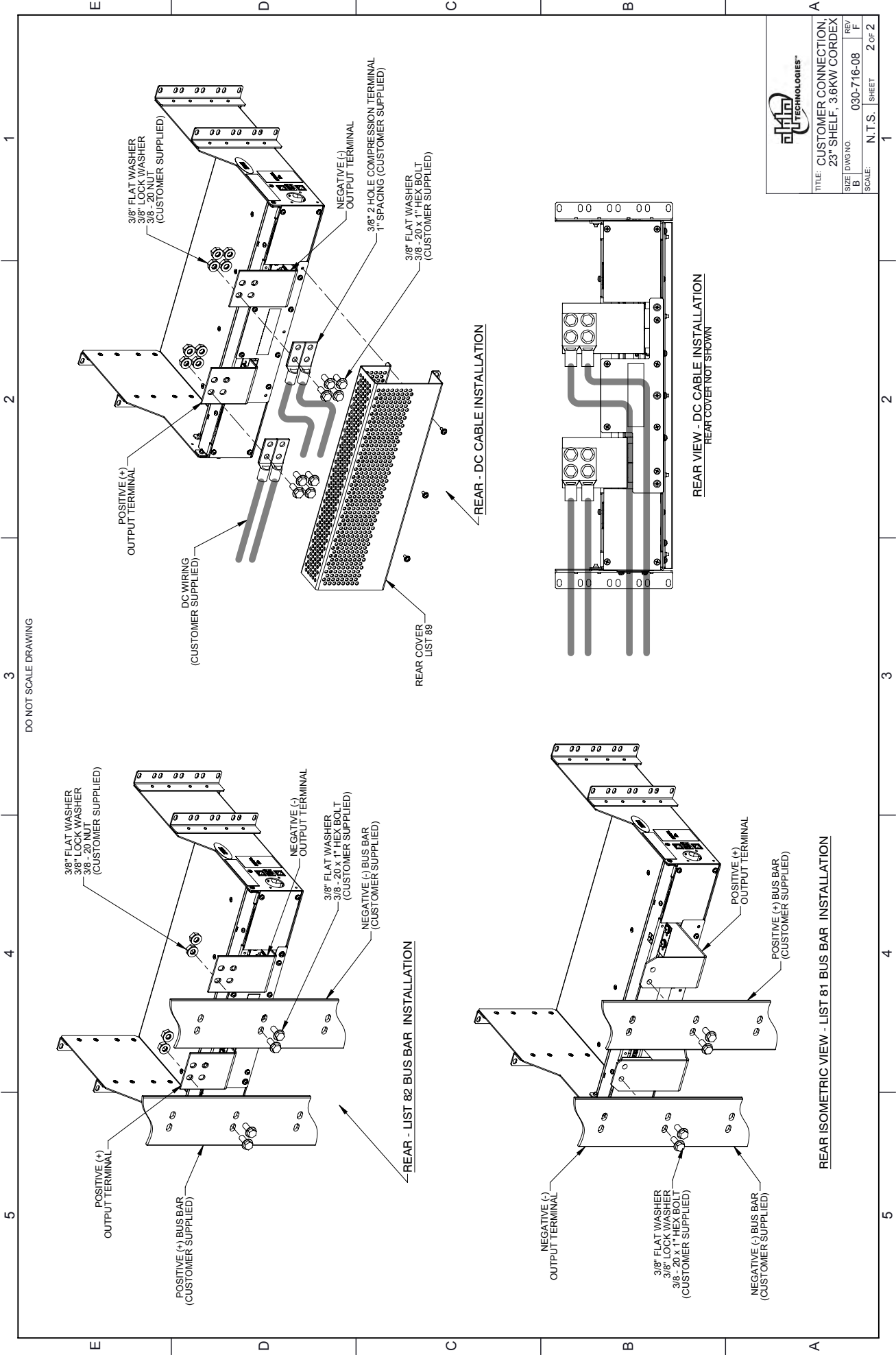

		TITLE: CUSTOMER CONNECTION, 23" SHELF, 3.6KW CORDEX
		SIZE DWG NO. 030-716-08
B	F	REV
SCALE: N.T.S.	SHEET	2 OF 2





Alpha Technologies Ltd. | 7700 Riverfront Gate, Burnaby, BC V5J 5M4 CANADA

Tel.: Toll Free North America: +1 800 667 8743 | Outside North America +1 604 436 5547 | Technical Support +1 888 462 7487

For more information visit our website at: [www.alpha.com](http://www.alpha.com)

© 2020 Alpha Technologies Ltd. All Rights Reserved. Trademarks and logos are the property of Alpha Technologies Ltd. and its affiliates unless otherwise noted. Subject to revisions without prior notice. E. & O.E.

[www.alpha.com](http://www.alpha.com)

#9400000-J0 REV E (06/2020)